

Instruction manual SMART

Laboratory freezers

models: ZLN 85
ZLN-T 125, ZLN-T 200, ZLN-T 300
ZLW-T 200, ZLW-T 300

Ultra-low freezers

models: ZLN-UT 130 VIP, ZLN-UT 200 VIP, ZLN-UT 300 VIP, ZLN-UT 500 VIP

Before using the equipment, please read carefully this instruction manual!

Version 1.35

Issued 3.11.2023



Manufacturer's address:

POL-EKO A.Polok-Kowalska sp.k.
ul. Kokoszycka 172 C
44-300 Wodzisław Śląski
Country of origin: Polska

As a manufacturer, we inform you that we took the necessary measures to ensure that this device fully meets your expectations and is reliable for a long period of use. Due to the continuous improvement of our products, as well as the expansion of our offer, any suggestions regarding additional functions and equipment functioning are welcome. Visit our homepage www.pol-eko.com.pl/home-en/

Equipment disposal















This equipment is marked with the crossed out wheeled bin symbol to indicate that this equipment must not be disposed of with unsorted waste. Instead it's your responsibility to correctly dispose of your equipment at lifecycle -end by handling it over to an authorized facility for separate collection and recycling. It's also your responsibility to decontaminate the equipment in case of biological, chemical and/or radiological contamination, so as to protect from health hazards the persons involved in the disposal and recycling of the equipment. For more information about where you can drop off your waste of equipment, please contact your local dealer from whom you originally purchased this equipment.

By doing so, you will help to conserve natural and environmental resources and you will ensure that your equipment is recycled in a manner that protects human health.

Thank you!

Contents:

1.	INTENDED USE AND IMPORTANT INFORMATION FOR THE USER	6
2.	PACKAGE CONTENTS	7
3.	BEFORE THE FIRST USE	7
3.1.	Installation of shelves	9
3.2.	Remarks on the placement of samples	12
3.3.	Closing chamber door	12
3.4.	Anchoring multi-chamber equipment	13
4.	DESCRIPTION OF THE DEVICE	14
4.1.	Design of ZLN 85	14
4.2.	Design of ZLN-T 125, ZLN-T 200, ZLN-T 300, ZLW 200, ZLW 300 devices	16
4.3.	Design of ZLN-UT 130 VIP, ZLN-UT 200 VIP, ZLN-UT 300 VIP, ZLN-UT 500 VIP devices	18
5.	DEVICE EQUIPMENT (standard and optional)	20
5.1.	Internal door (standard for ZLN-UT VIP)	20
5.2.	Door lock (standard for all units)	20
5.3.	Access port for external sensor (standard for all units)	20
5.4.	Open door alarm (standard for all units)	20
5.5.	USB port (standard for all units)	21
5.6.	Display battery backup (optionally for ZLN, ZLN-T, ZLW-T, standard for ZLN-UT VIP)	22
5.7.	Consumables	22
6.	DEVICE OPERATION	22
6.1.	External memory (USB flash drive)	23
6.2.	First boot	23
6.3.	 Main screen	23
6.3.1.	Information panel	24
6.3.2.	The meaning of icons and symbols	27
6.3.3.	Upper menu	28
6.3.4.	Alarm bar	30
6.4.	Quick Program	30
6.5.	 Programs	32
6.5.1.	Creating / editing a program	32
6.5.2.	Segments edition	33
6.5.3.	Summary of segments	35
6.5.4.	Priority	36
6.5.5.	Loop	37
6.5.6.	Defrosting of ZLN, ZLN-T, ZLN-UT VIP devices	37
6.6.	Starting the program	37
6.6.1.	The first way	37
6.6.2.	The second way	39
6.7.	Quick Change of parameters	40
6.7.1.	Quick change of set temperature	40
6.7.2.	Quick change of set time	41

6.8.		Statistics	42
6.9.		Data record.....	42
6.10.		Event log	44
6.11.		Info	46
6.12.		User settings panel.....	46
6.12.1.		Unlocking the touch screen	47
6.13.		Time	48
6.14.		Alarms	49
6.14.1.		Alarms when set parameters are exceeded	49
6.14.2.		Open door alarm	50
6.14.3.		STM function	51
6.14.4.		Mute option.....	53
6.15.		Network	53
6.16.		Automatic defrosting function (standard for ZLW-T)	54
6.17.		Corrections.....	55
7.		INTERFACE.....	56
7.1.		MODBUS TCP.....	56
8.		co₂ back-up SYSTEM (OPTIONALLY FOR ZLN-UT VIP).....	56
8.1.		Indications for using pressure cylinders	57
8.1.1.		Characteristics of carbon dioxide	58
8.1.2.		Hazards when working with CO ₂	58
8.1.3.		Personal protection	58
8.1.4.		Control devices.....	59
8.1.5.		First aid.....	59
8.2.		User's responsibility	60
8.3.		Emergency shutdown of the CO ₂ back-up system.....	60
8.4.		Connecting the freezer to a CO ₂ cylinder.....	60
8.5.		Disconnecting the freezer from the CO ₂ cylinder	63
8.6.		CO ₂ Backup solenoid valve	63
8.7.		Starting the device	63
9.		CONNECTING THE DEVICE TO A COMPUTER.....	64
10.		CLEANING AND MAINTENANCE OF THE DEVICE	64
10.1.		Exterior cleaning	64
10.2.		Interior cleaning	64
10.3.		Cleaning the touch screen	65

Instruction manual ZLN, ZLN-T, ZLW-T, ZLN-UT VIP SMART

11. ADVICE ON HOW TO SAFELY STORE THE DEVICE.....	66
12. TROUBLESHOOTING.....	66
12.1. Possible defects.....	67
13. WARRANTY CONDITIONS.....	67
14. RATING PLATE.....	68
15. TECHNICAL DATA.....	69
15.1. ZLN, ZLN-T, ZLW-T devices.....	69
15.2. ZLN-UT VIP devices.....	71
16. DECLARATIONS OF CONFORMITY.....	73

1. INTENDED USE AND IMPORTANT INFORMATION FOR THE USER





Laboratory freezers are laboratory equipment intended for freezing and storage of frozen samples below 0°C:

- laboratory freezer ZLN: -25°C ... 0°C
- laboratory freezer ZLN-T: -40°C ... 0°C
- laboratory freezer ZLW-T: -40°C ... 0°C
- ultra-low freezer ZLN-UT VIP: -86°C...-50°C

All devices are controlled by a precise SMART controller, thanks to which the set temperature is maintained with good fluctuation and variation. The ZLN 85 freezer is also available in a 2-chamber version with ST thermostatic cabinet or CHL laboratory refrigerator, where each chamber is independently controlled – for service and operation of ST and CHL devices, see the relevant instruction manual. In 2-chamber devices, the freezer is always at the bottom.

For devices with forced air convection, the symbol  appears on the screen.

The meaning of information symbols

	This symbol means that failure to follow the instructions could endanger people's health or life, or damage the device. The manufacturer is not liable for damages resulting from non-compliance with the instructions contained in the manual.
	A flammable coolant is used in the cooling system. If the cooling system is damaged, ventilate the room carefully and remove all open flames near the unit.
	There are extremely low temperatures inside the chamber so do not touch the samples and the interior of the chamber without suitable protective gloves.
	This symbol indicates helpful tips.

To guarantee your security and the longevity of the unit, please comply with the following rules:

1.	<p><u>The unit cannot be installed:</u></p> <ul style="list-style-type: none"> • outside, • in damp places or places which can be easily flooded, • near flammable or volatile substances, • near acids or in corrosive environments.
2.	<p><u>It is forbidden to:</u></p> <ul style="list-style-type: none"> • store inflammable or volatile substances inside the unit, • touch live parts of the unit, • operate the unit with wet hands, • put water vessels on the unit, • climb on the unit, • overload the shelves (the maximum load is described in technical data), • place objects on the bottom of the chamber.
3.	<p><u>You should:</u></p> <ul style="list-style-type: none"> • place samples in such a way to provide proper air circulation in the chamber, • open the door for the shortest period of time to reduce temperature fluctuations, • secure samples from being blown out by the chamber fan e.g powdery samples, • always check that the doors are closed correctly, • use only mains with earth to avoid electric shocks, • unplug the power cable holding the protective cover and not the cable itself, • disconnect the unit from the mains before undertaking any repairs or maintenance work (in order to not

- lose the warranty during its duration, all repairs should be carried out by an authorized service),
- protect the power cable and the plug from any damage,
 - disconnect the power plug before moving the unit,
 - disconnect the power plug if the device will not be used for a long period of time,
 - disconnect the unit and protect it from reconnecting if it has any visual fault.

Failure to comply with the above recommendations may result in damage to the device or deterioration of technical parameters, as well as loss of warranty.

2. PACKAGE CONTENTS

ZL laboratory freezers in SMART version are delivered with:

Device	ZLN	ZLN-T			ZLW -T		ZLN-UT VIP			
Capacity	85	125	200	300	200	300	130	200	300	500
Shelves [pcs.]	2	2	2	3	2	3	1	2	2	4
Slides [pcs.]	4	4	4	6	4	6	x	x	x	x
Power cord [pcs.]	1	1	1	1	1	1	1	1	1	1
Silicone cap [pcs.]	2	2	2	2	2	2	2	2	2	2
Key for door lock [pcs.]	2	2	2	2	2	2	2	2	2	2
Wrench (13mm) for wheels adjustment [pcs.]	x	x	x	1	x	1	1	1	1	1
Quality Control Certificate [pcs.]	1	1	1	1	1	1	1	1	1	1

3. BEFORE THE FIRST USE

The manufacturer sends the device protected by cardboard profiles and foil. The device **should be transported in an upright position** and the package should be secured against sliding during transport.



After receiving the device, visually assess its condition and equipment in the presence of the person delivering the goods. A courier company is responsible for any damage caused during transport.



While carrying the unit, do not tilt it to one side more than 45° from the upright position, as there is a high probability of damaging the compressor. If it is necessary to tilt it to one side more than 45°, then after placing it, please wait about 3 hours before connecting the unit to the mains.



After transporting the device at a temperature below 10°C, wait at least 2 hours before connecting it to the mains.

On the surface of unit's components made of stainless steel, slight discoloration may occur. It is a result of the technologies used in the production of metal sheet in accordance with the requirements of PN-EN 10088-2 standard and it is not a defect of the unit.

The place of installation of the unit should meet the following conditions:

- ambient temperature +10°C...+28°C,
- recommended relative humidity of the ambient air up to 60%,
- the unit has not been designed to work in highly dusty environments,
- ensure proper ventilation in the room,
- the device should be placed on a hard and stable surface,
- the unit should be placed at least 100mm away from the walls,
- the height of the room must be at least 300mm greater than the height of the unit,
- the unit is not designed to be built-in,
- the place of installation of the device should be equipped with a socket with parameters suitable for the device.

If you don't comply with the above recommendations, the unit may get broken or it may worsen the technical parameters such as:

- temperature fluctuation,
- temperature variation,
- power consumption,
- icing of evaporator

and may result in loss of warranty.

Wheels / leveling feet

	<p>If the device has been equipped with wheels or leveling feet:</p> <ul style="list-style-type: none">• in the case of wheels after placing the unit at its destination, secure the device against movement by locking the wheels• in the case of feet, after placing the device in the destination, they should be leveled.
---	--

If the device is equipped with wheels, they must be locked. For this purpose use the red knob mounted in the wheel housing. At the beginning, the knob can be turned by hand, if it encounters resistance, use a 13 size wrench.

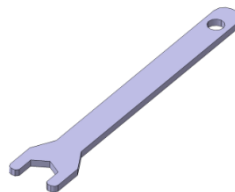

	<p>Leveling wheels are ONLY for positioning the device at its destination. They can not be used to transport the device!</p>
---	---

Electric installation

	<p>Power supply of the equipment is indicated on a rating plate on the unit. Connect the device to a socket with ground in order to avoid electric shocks in case of the unit's failure.</p>
---	--

The installation should be protected by a 16A slow-blow fuse and equipped with a residual current device.

3.1. Installation of shelves

In the ZLN 85 freezer

To install the shelf or to change its position, follow these steps:

Install the shelf slide at the selected height by inserting it into proper slots on the wall of the device. Do the same with the slide on the opposite wall.

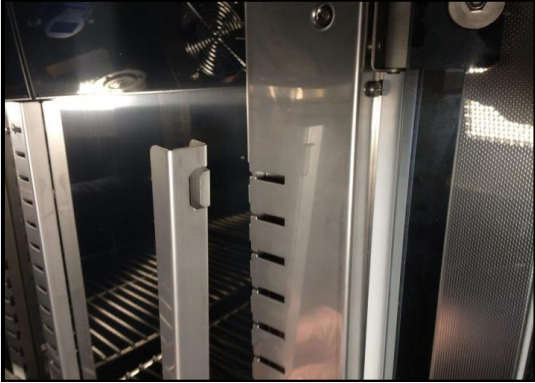

Slide the shelf into the installed shelf slides. Now, the shelf is correctly installed!



To remove a shelf, perform the above steps in reverse order. To remove the shelf slide from the slots, lift it up and slide it towards the rear of the chamber.

Instruction manual ZLN, ZLN-T, ZLW-T, ZLN-UT VIP SMART

In the ZL-T 125, ZL-T 200, ZL-T 300 models

To install the shelf or to change its position, follow these steps:

Install the shelf slide at the selected height by inserting it into proper slots on the wall of the device. Do the same with the slide on the opposite wall.



Slide the shelf into the installed shelf slides. Now, the shelf is correctly installed!

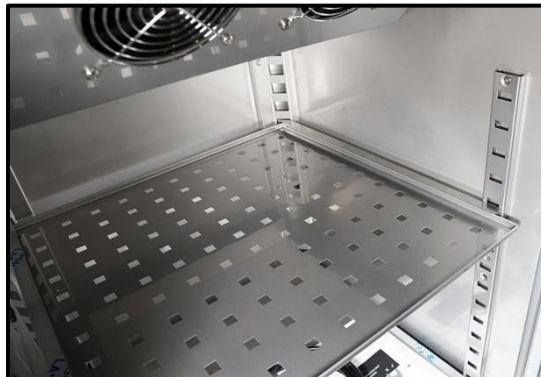

In the freezers: ZLN-T 125, ZLN-T 200, ZLN-T 300 there are full shelves with a hole in the middle in standard equipment.

In the freezers: ZLW-T 200 and ZLW-T 300 there are perforated shelves (as shown above) in standard equipment.

To remove a shelf, perform the above steps in reverse order.

Instruction manual ZLN, ZLN-T, ZLW-T, ZLN-UT VIP SMART

In the ZLN-UT 130 VIP, ZLN-UT 200 VIP, ZLN-UT 300 VIP and ZLN-UT 500 VIP models

In the ultra-low freezers ZLN-UT 200 VIP and ZLN-UT 300 VIP each separately closed compartment is equipped with a shelf. In the ZLN-UT 500 VIP freezer, in each of the two separately closed compartments there are two shelves. In the model ZLN-UT 130 VIP there is one compartment with one shelf.



ZLN-UT 500 VIP

Figure 1 Compartments in ultra-low freezers ZLN-UT 130 VIP, ZLN-UT 200 VIP, ZLN-UT 300 VIP, ZLN-UT 500 VIP

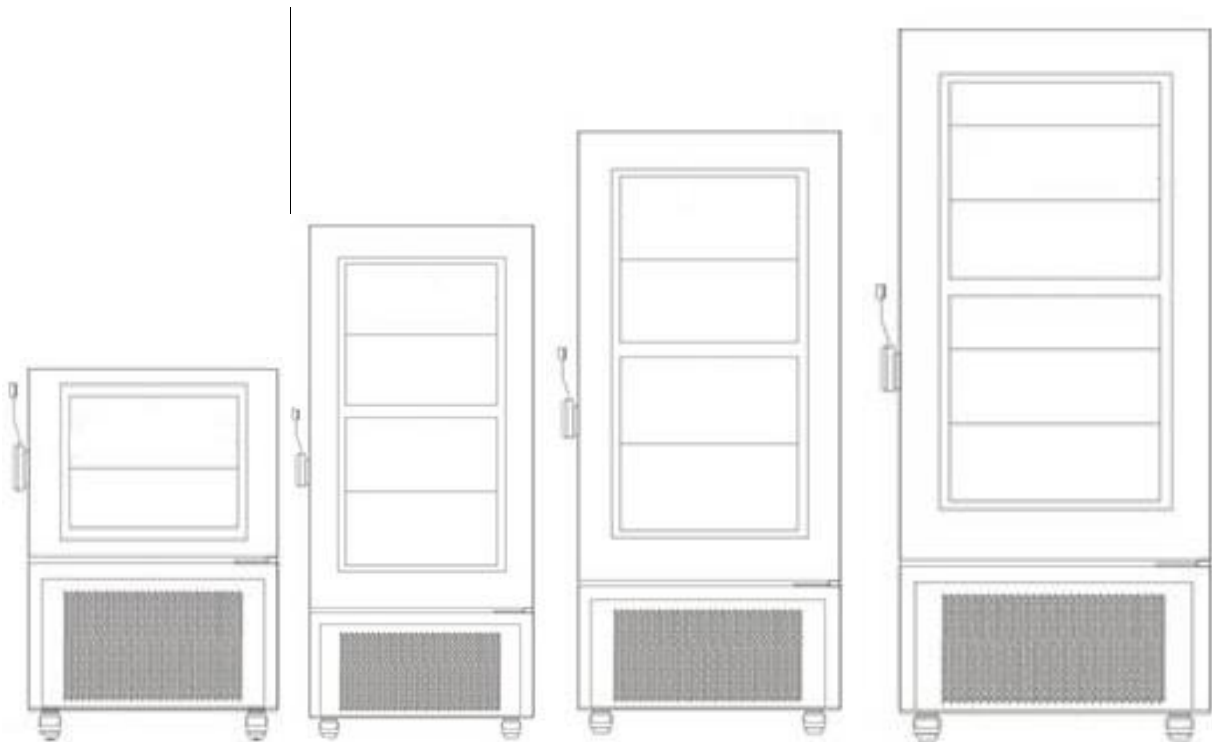

3.2. Remarks on the placement of samples

To provide proper air circulation and stable conditions in which the samples are stored in the chamber, it is necessary to keep the following rules:

- the max height of the samples should not exceed 1/3 of the space between the shelves,
- approx. 1/3 of the width and depth of the shelf should remain empty, while the distances between the samples, as well as between the samples and the wall should be approximately equal.

The picture below is an example of the placement of samples in the chamber.

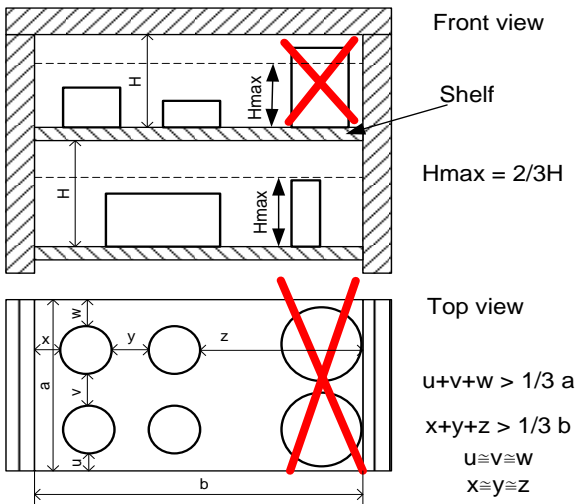

Following the above rules will provide best optimal parameters of temperature fluctuation and variation.

3.3. Closing chamber door

Freezers door have been equipped with a gasket and open door sensor. The external door of the ZL-T and ZL-UT VIP freezers are equipped with a lock. In ultra-low freezers each compartment is closed with a separate door.

If the door has not been closed properly, an audible and visual alarm will start. You can set delay door alarm by: 30s, 1 min, 2 min, 5 min or 10 min ([see Section 6.14](#)).

3.4. Anchoring multi-chamber equipment



In the case of high multi-chamber units (ST/ZLN 85 or CHL/ZLN 85) they must be anchored to the wall with suitable fixings (the anchoring kit is supplied with the device). This prevents the unit from falling over. **Lack of anchoring may result in damage to the device and in extreme cases may endanger the health or life of the person who using the device.**

Rear view

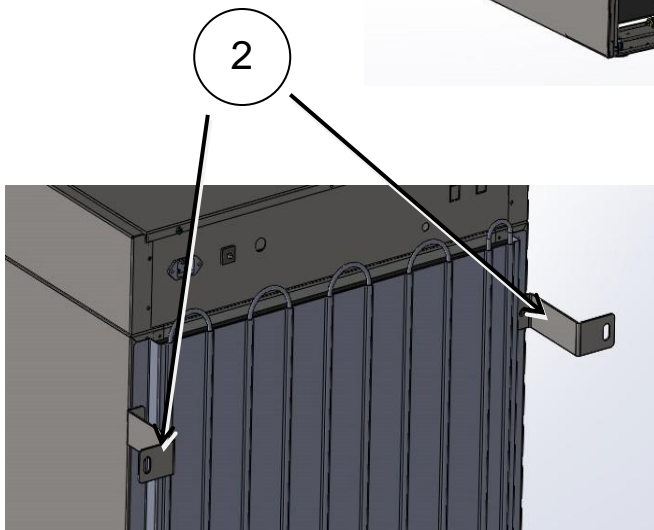
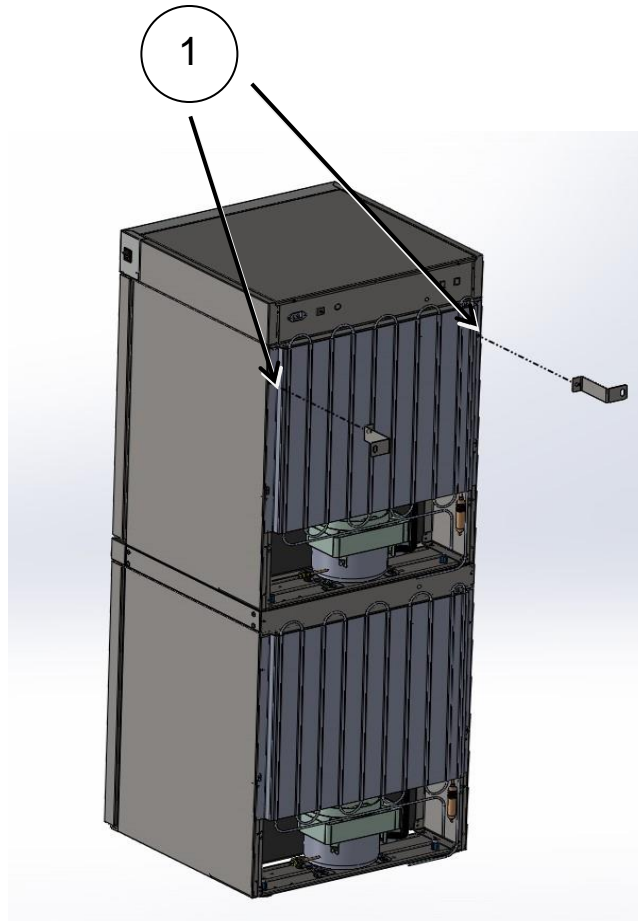

1. Install the mounting brackets (2) to the holes marked (1) on the back of the device using the supplied screws and nuts. Handles can be set up or sideways.
2. Place the equipment at the destination.
3. Use the \varnothing 6 mm wall plugs adapted to the anchoring point to attach the holders. Elongated mounting hole in the bracket 10x10.

4. DESCRIPTION OF THE DEVICE

SMART models are equipped with a PID microprocessor temperature controller and a 4.3 inch colour touch screen with a resolution of 800x480.

4.1. Design of ZLN 85

Below there's a picture of ZLN 85 model with a description of the important components of the device.

Front view

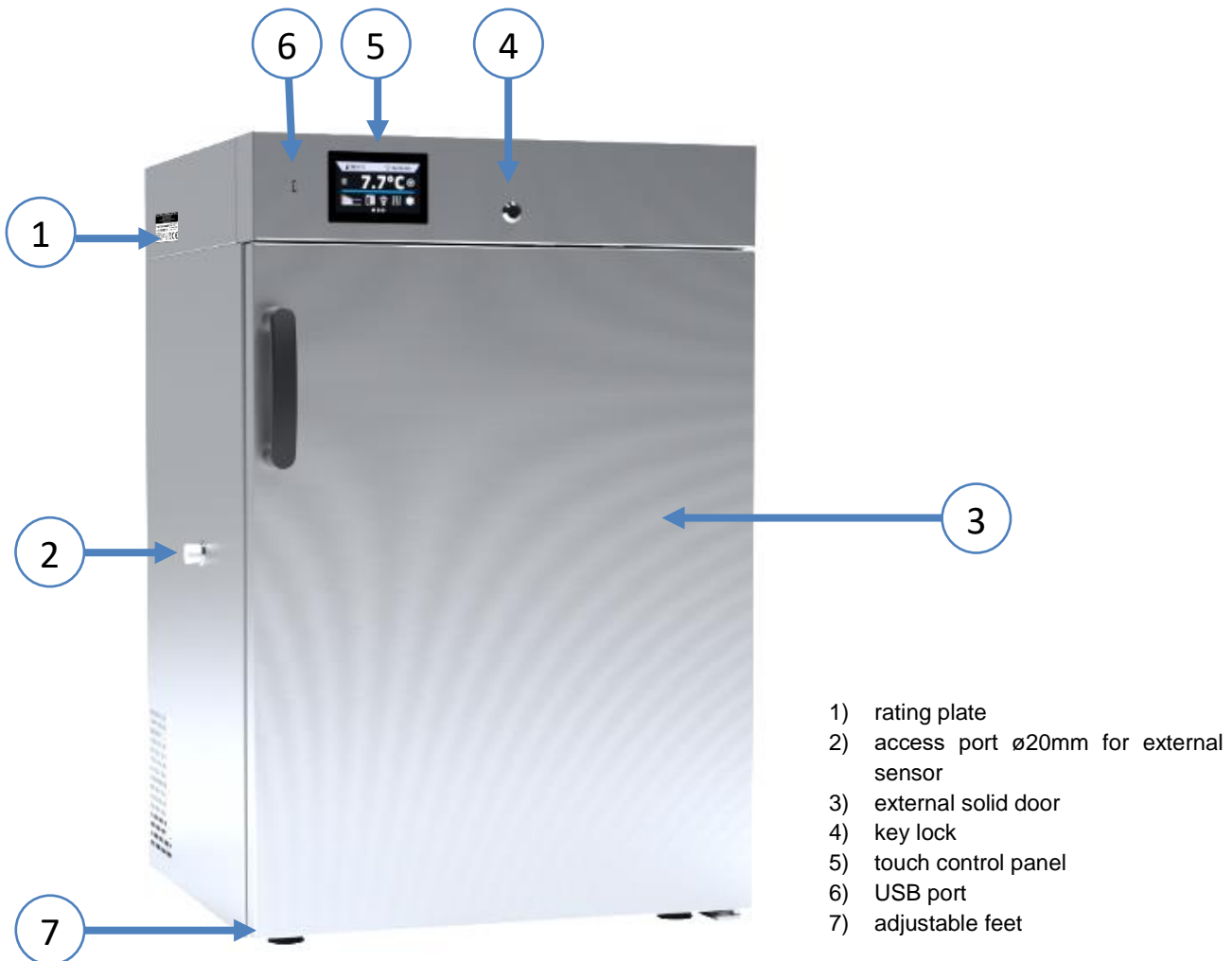

Rear view

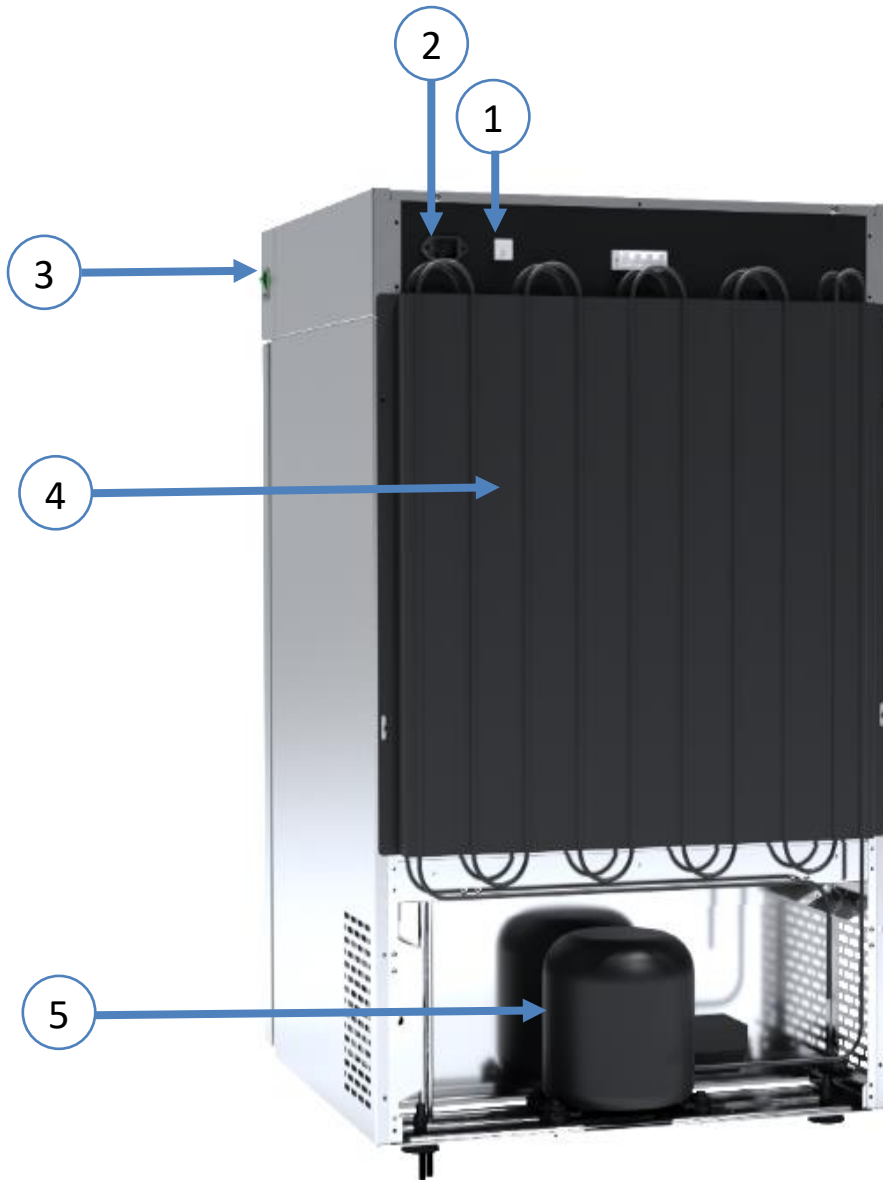

- 1) fuse
- 2) main power socket C14
- 3) main switch
- 4) condenser
- 5) cooling system

4.2. Design of ZLN-T 125, ZLN-T 200, ZLN-T 300, ZLW 200, ZLW 300 devices

Below there's a picture of ZLN-T 200 model with a description of the important components of the device.

Front view



- 1) rating plate
- 2) handle with bolt lock with a key
- 3) main switch
- 4) wheels
- 5) condenser housing
- 6) external solid door
- 7) touch control panel

Rear view

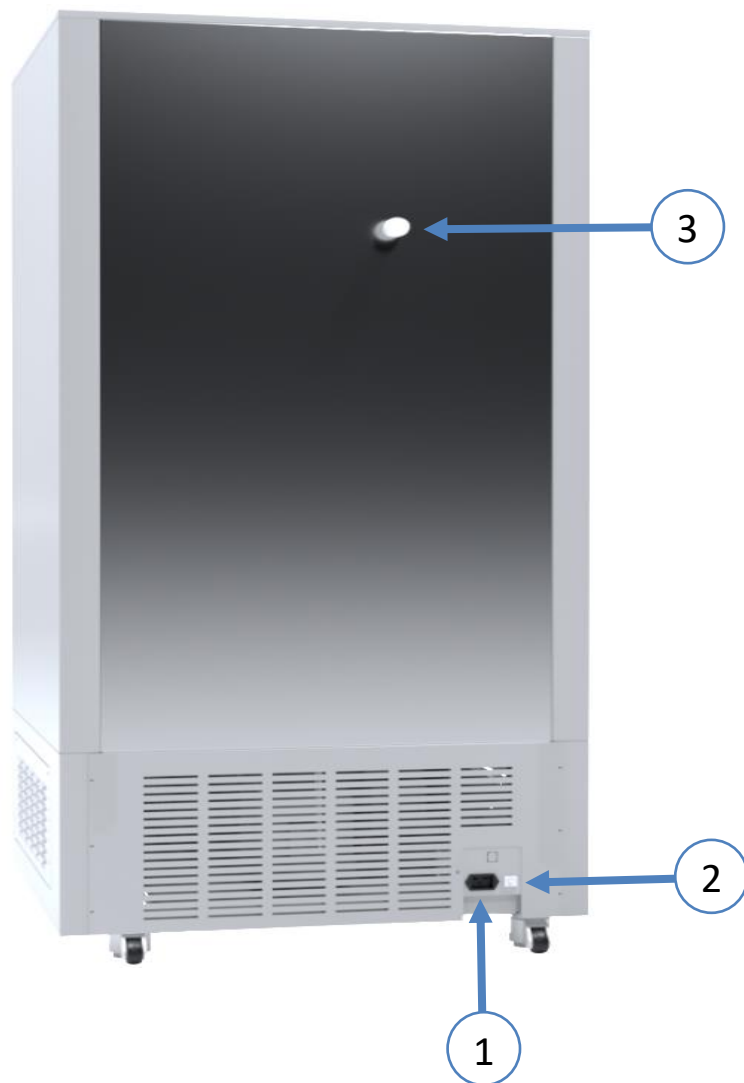

- 1) main power socket C20
- 2) fuse
- 3) balancing valve

4.3. Design of ZLN-UT 130 VIP, ZLN-UT 200 VIP, ZLN-UT 300 VIP, ZLN-UT 500 VIP devices

Below there's a picture of ZLN-UT 500 VIP model with a description of the important components of the device.

Front view

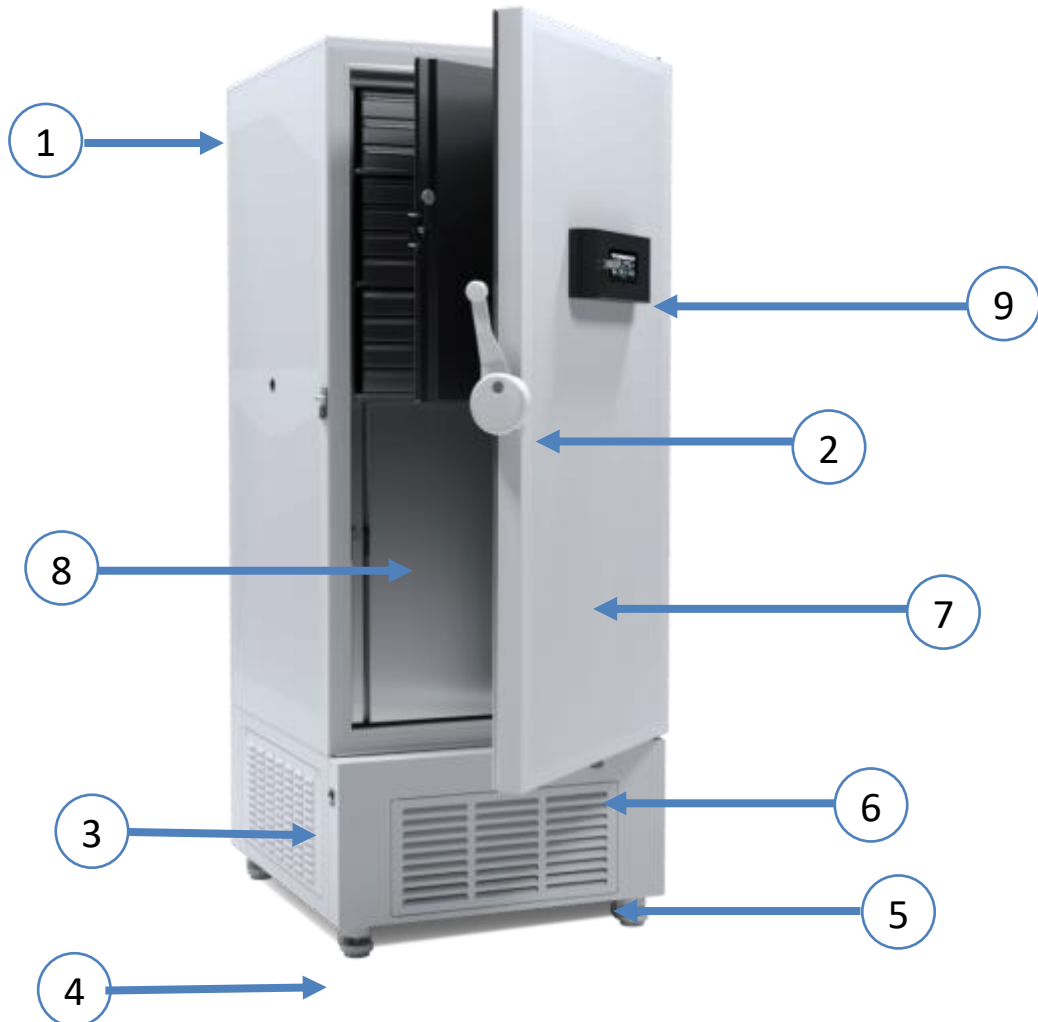

- 1) rating plate
- 2) handle with bolt lock with a key
- 3) main switch
- 4) wheels
- 5) condenser housing
- 6) emergency back-up system switch
- 7) external solid door
- 8) internal door
- 9) touch control panel

Rear view

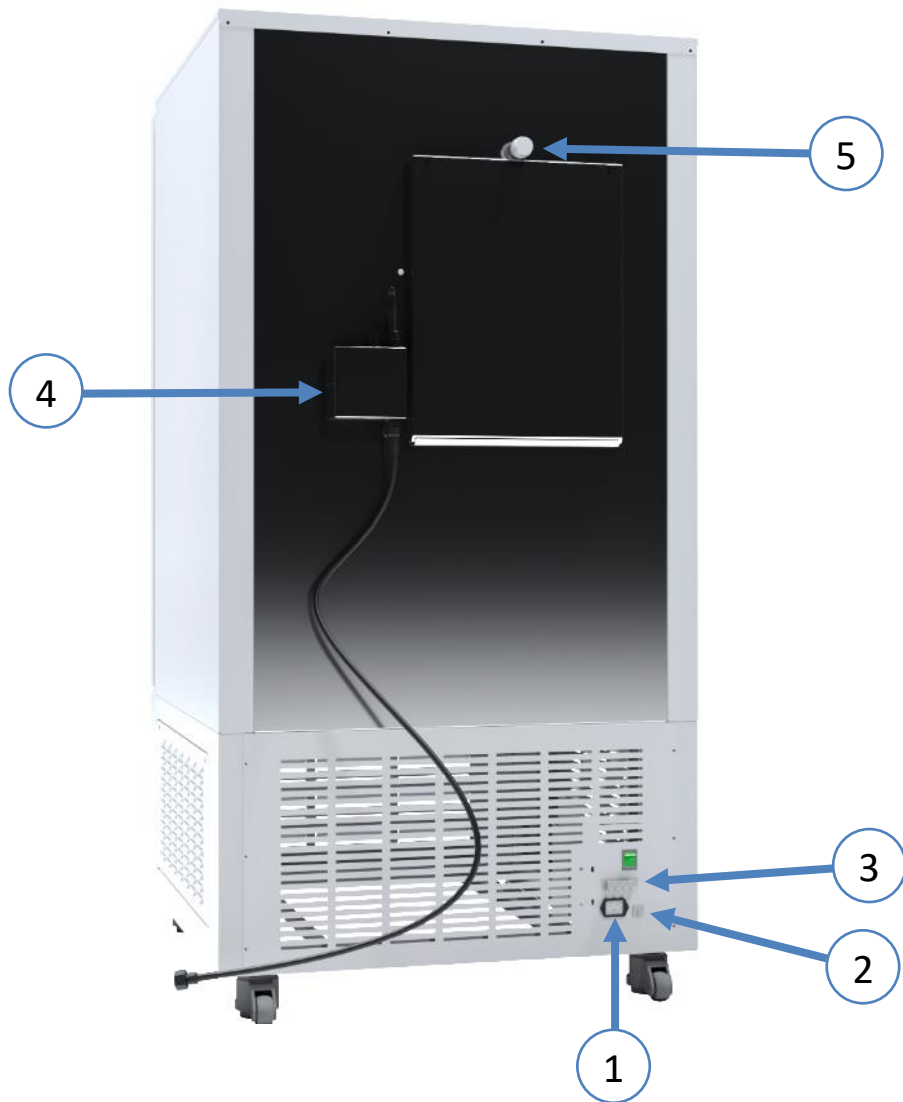

- 1) main power socket C20
- 2) fuse
- 3) potential-free alarm contact (option)
- 4) CO2 back-up system (option)
- 5) balancing valve

5. DEVICE EQUIPMENT (STANDARD AND OPTIONAL)

5.1. Internal door (standard for ZLN-UT VIP)

The interior of the ultra-low freezers ZLN-UT 130 VIP, ZLN-UT 200 VIP, ZLN-UT 300 VIP and ZLN-UT 500 VIP has been divided into compartments, which are additionally isolated by means of the internal doors. This allows samples to be removed without the risk of temperature rise in other compartments.

5.2. Door lock (standard for all units)

All devices have a key lock. In the model ZLN 85 the key lock is situated above the door. In the freezers ZLN-T, ZLW-T and ZLN-UT VIP the bolt lock is located in the door handle. Two keys are supplied with the device.



5.3. Access port for external sensor (standard for all units)

A Ø20 mm access port can be used to insert an external temperature sensor for independent temperature control inside the device. The access port has been secured with a silicone plug. The plug should cover the access port while the unit is operating. If multiple cables have been inserted through the access port and it is not possible to use the plug, secure the access port with adhesive tape. If you leave the access port open, it may affect temperature fluctuation and variation inside the chamber.



5.4. Open door alarm (standard for all units)

All units have been equipped with an open door sensor. If you open the door, the icon:  will appear (the number above the icon presents open door counter. Press the icon to cancel the counter. The counter is also cancelled by turning of the device). If the door remains open longer than the time set by the user (30s, 1 min, 2 min, 5 min, 10 min) an acoustic signal, red pulsating alarm bar and „open door” alarm with active status will appear.



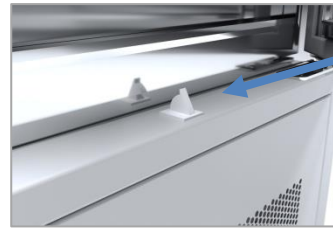

Open door sensor
in ZLN 85



Open door sensor in
ZLN-T and ZLN-UT
VIP

5.5. USB port (standard for all units)

The USB port on the front panel is used only to transfer data from the device's internal memory to the flash drive. To do this insert the flash drive into the USB port on the front panel and then:

- go to the main menu ,
- go to the data record ,
- press  and choose type of the file: *.csv, or *.plx.
- press . Data has been copied.



After copying the data to the USB flash drive, before removing it from the USB socket, it should be unmounted by pressing the icon  in the top drop-down list (Figure 1). If the pendrive is not unmounted after connecting to the computer, a message about pendrive damage may be displayed with a repair proposal, when actually the pendrive is not damaged

Figure 1 Unmounting



Data saved in the *.csv file can be opened in a spreadsheet. Data saved as *.plx can be opened in the Lab Desk program (additionally paid option). This program allows, among others, for data preview in the form of a table or a graph. It also allows you to prepare a statistic report for a selected range of data. More information [Section 6.1](#).

5.6. Display battery backup (optionally for ZLN, ZLN-T, ZLW-T, standard for ZLN-UT VIP)

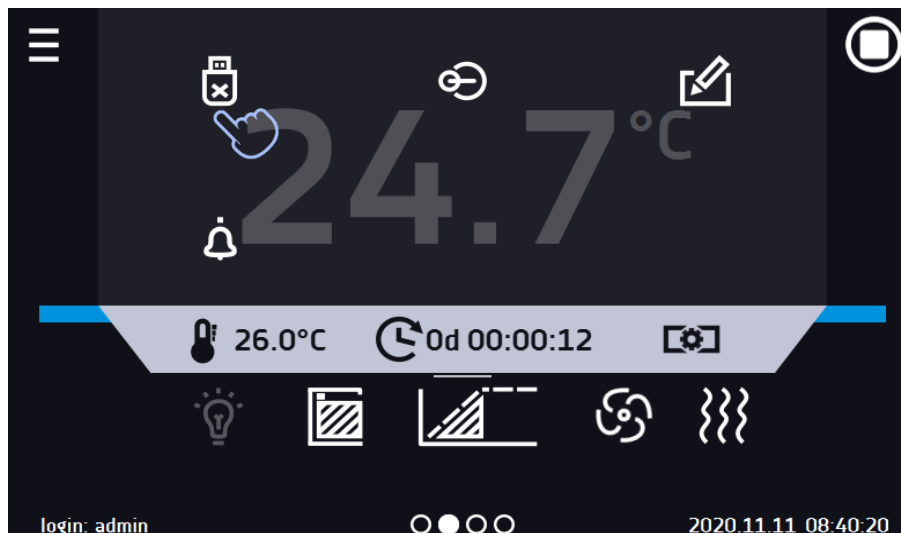
Units in the SMART version can be optionally equipped with a battery backup of the display. The power loss and switching to the battery backup display mode is signaled by a pulsating red frame around the display and a sound signal (if it is turned on). In the battery backup display mode, all parameters are displayed, ie temperature. Other alarms, e.g. exceeding the temperature range, are also signaled.

In order to extend the battery life, the display is dimmed all the time. Batteries are automatically charged in AC mode.

	Batteries should be replaced every 12 months. When it is time to replace the battery, a message will appear on the display, see Figure 2 . During the warranty period, the replacement should be performed by an authorized service. Otherwise, you will lose your warranty.
---	--

Figure 2 Battery replacement message



5.7. Consumables

Consumables during normal operation are:

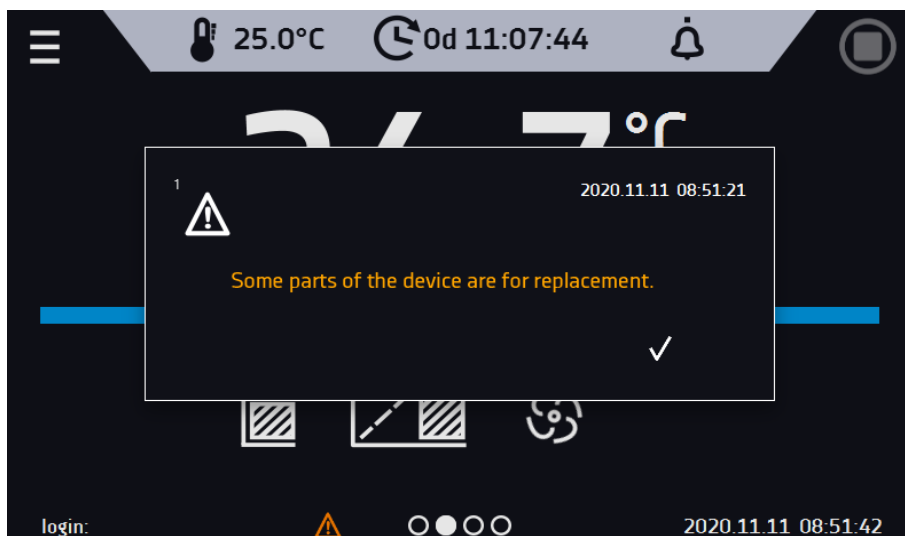
- silicone door seal - in all units,
- chamber fan - in equipment with forced air convection,
- interior lighting bulb - in units with the option of interior lighting.

6. DEVICE OPERATION



This symbol means that a given window can be moved in the direction shown in the picture.

6.1. External memory (USB flash drive)

The external memory (USB flash drive) allows to copy: instruction manual, data record, event log and service log from the device memory. Before first use the USB flash drive should be formatted in the FAT 32 file system. Insert the device in the USB slot on the front of the device next to the display. Wait a few seconds, the correct reading is indicated by the message „USB flashdrive connected” at the bottom of the screen.



After copying the data to the USB flash drive, before removing it from the USB socket, it should be unmounted (see [Section 5.5](#)).



USB slot is used to connect **only** a flash memory – a flash drive or a card reader with a memory card. Connecting any other device (e.g. external hard drive) without consultation is not authorized by the manufacturer and may damage the USB slot.

6.2. First boot

During the first boot, the screen ([Figure 3](#)) will display information about saving the "Download" folder (with instruction manual in pdf format) on the USB flash drive. In order to do it, insert the USB flash drive and wait a second to detect the hardware, then press .

If you press  you quit downloading the folder. The window will appear again during the next boot. You can tick „Don't show again” so that the window will not be displayed after switching on the device. You can always download the „Download” folder in the Info submenu. More information [Section 6.11](#).

Figure 3 Downloading files



6.3. Main screen

After switching on the device, the main screen ([Figure 4](#)) appears. It contains the information about the device status. After starting the program, additional information appears on the screen ([Figure 5](#)). For devices with forced air convection (ZLW-T 200, ZLW-T 300) symbol  appears on the screen.

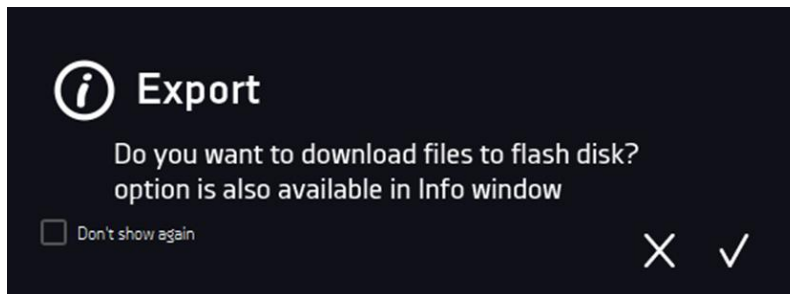
Figure 4 Main screen

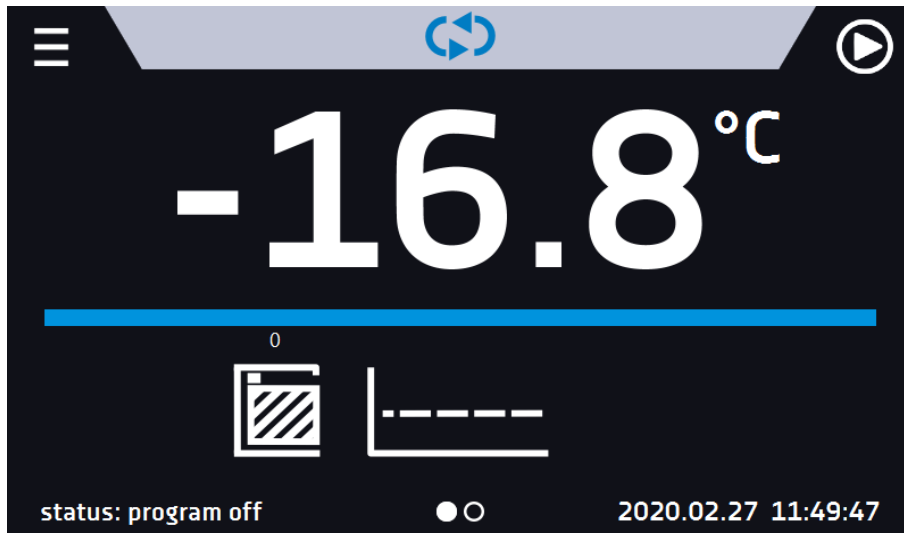
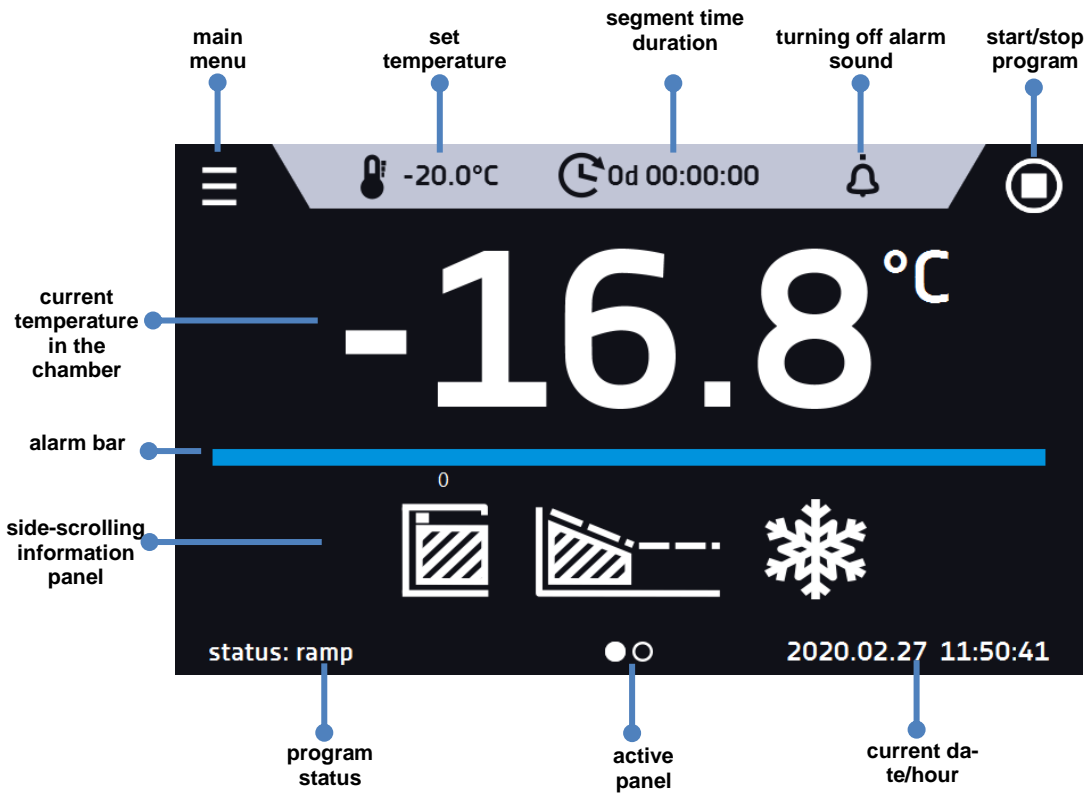

Figure 5 Main screen – running program in ZL



6.3.1. Information panel

There are two different windows in the information panel. Switching between them is done by swiping the finger left or right.





The icon  indicates information about which window is active.

6.3.1.1. Alarms panel

The icon  which is on the second page of the information panel, allows you to go to the alarms panel.

Figure 6 Icon: Alarms panel



In the alarms panel (Figure 7) there's a list with active alarms or the alarms that have occurred but have not been confirmed. When the alarm is active, the alarm bar is red and the alarm event is displayed in the list with the status "active". When the alarm event stops, the state changes to "inactive".

- "delete" button – confirms and removes the alarm from the list (only inactive alarms can be deleted),
- "confirm" button – confirms an alarm,
- "details" button – displays a preview of all instances of selected alarm (Figure 8).

Figure 7 Alarms panel

 Alerts			
alarms	info	state	confirm
door open	<u>details</u>	inactive	<u>delete</u>
lower overrun temperature	<u>details</u>	active	<u>delete</u>

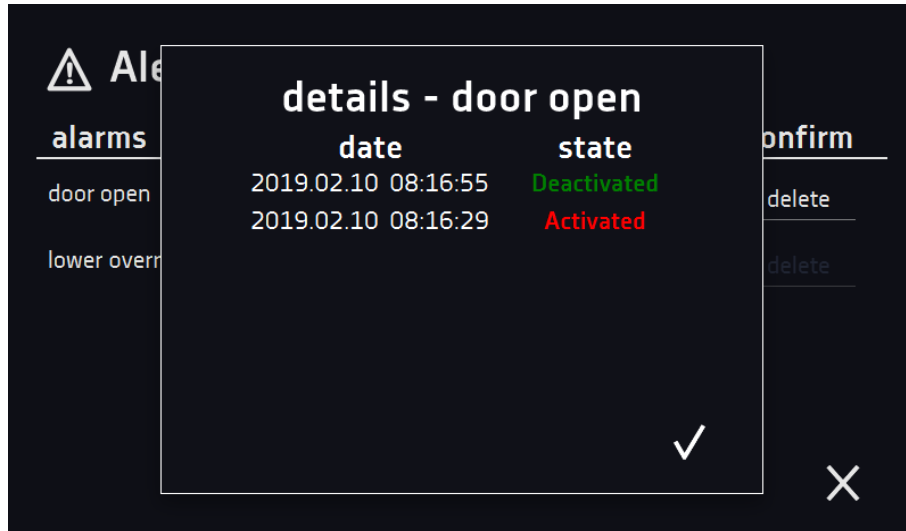

Figure 8 Alarm details



6.3.1.2. Status panel

The icon  which is on the second page of the information panel, allows you to go to the status panel.

Figure 9 Icon: Status panel







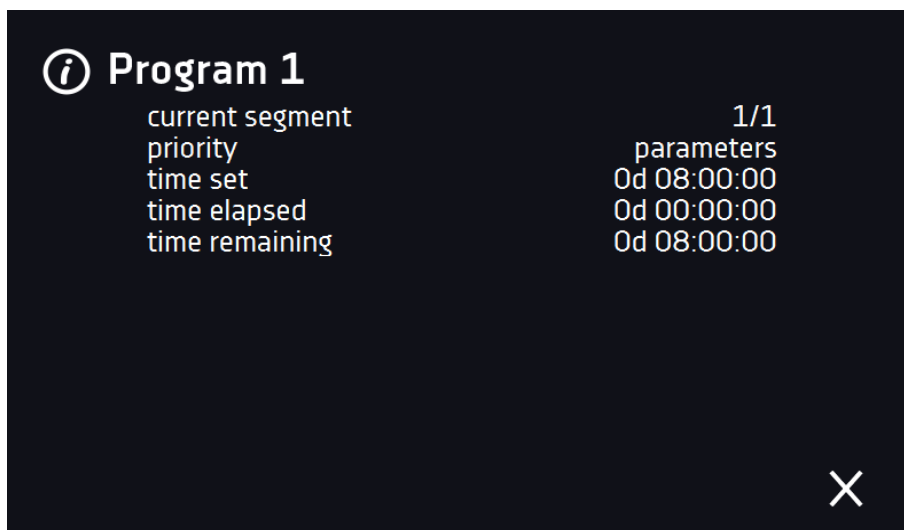











The status of the device is indicated also by description.















Figure 10 Status – description



program name	the name of running program
current segment	currently running segment / total number of segments in the program
priority	of time or parameters
time set	set time of running segment
time elapsed	elapsed time since the segment has started
time remaining	remaining time until the end of the segment

6.3.2. The meaning of icons and symbols



	The icon allows you to go to the main screen.
	Automatic return to the home screen. Factory setting: disabled.
	The icon allows you to go to the main menu.
	Automatic screen lock. Factory setting: disabled.
	Unmounting the USB flash drive before removing it from the USB socket.
	Closed door, open door. The number above the icon presents open door counter. Press the icon to cancel the counter. The counter is also cancelled by turning of the device.
	Fan icon. Rotating icon shows that the fan is running (for ZLW-T).
	Ramp status: Chamber is currently cooling down.
	Set temperature is reached.
	The program will start on the given date / time. Start delay activated.
	Icon is visible only when the chamber is cooling down.
	Available when the program is running. Clicking the icon allows you to quickly change the set temperature (Quick Change function).
	When the program is running, click the icon to quickly change the time of program duration (Quick Change function). Indicates the time that has elapsed from the program start.
	Countdown of the time remaining to the end of the program.
	The arrow icon allows navigation between: segments, program parameters and summary.
	Starting the selected program. In the list of programs - the program is running.

	Stopping the program.
	Adding a new program to the program list. The user can create up to 5 programs.
	Editing the selected program from the list. In the program list, a new program has been created but not approved yet.
	Removing selected program from the list.
	Going to alarms panel.
	Going to the status panel with information about the program parameters.
	Going to the menu to create, edit, delete and start programs.
	Canceling adding or editing of the program. Canceling changes.
	Editing individual program segments (the program can have max. 6 segments).
	Immediate start of the program selected from the program list.
	Delayed start of the program from the list of programs. The program starts according to the set date and time.
	Going to the SMART program (Quick Program function).
	Turning off of the alarm sound (open door alarm, exceeding temperature range). Critical alarms (i.e. damage to the temperature sensor, temperature protection, etc.) continue emitting a sound.
	Active STM function (Smart Temperature Monitor) informs the user about the problem of reaching or maintaining the set temperature. <ul style="list-style-type: none"> white color - option enabled, the program is stopped blue color - option enabled, the program is running red color - warning about problems with reaching / maintaining the temperature

6.3.3. Upper menu

When the program is running, in the upper part of the main screen there's a bar menu with parameter icons (temperature, time, mute function). These parameters can be quickly changed (Quick Change).

There are the following icons:

-  USB flash drive unmounting – more information [Section 5.5](#).
-  mute option. Critical alarms e.g. damage to the temperature sensor will be still emitted. See [Section 6.14.1](#).



- Quick Change (more information [Section 6.7.](#)) of:
 -  program duration time
 -  set temperature

Figure 11 Upper menu

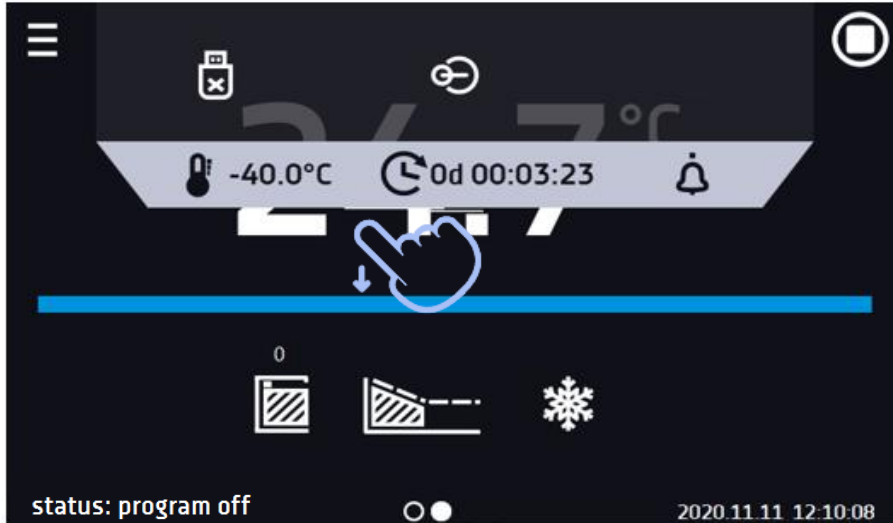
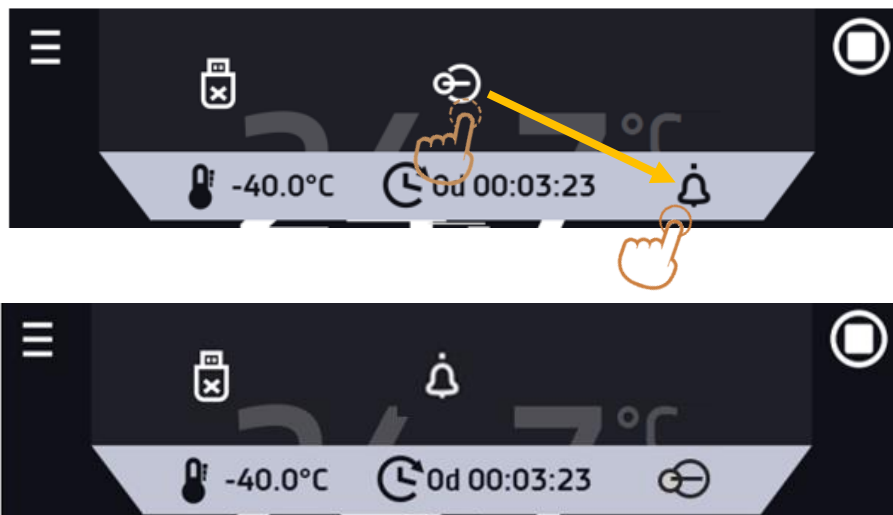

Figure 12 Upper menu when the program is stopped



Figure 13 Changing icon's position



6.3.4. Alarm bar

The alarm bar is a quick visual information about the device status. The colour of the bar indicates the status of the device:

 – blue - the device is working properly

 – red bar and pulsating frame – active alarm

6.4. Quick Program

Quick program allows you to quickly start the program from the main screen position without having to enter to the menu .

The Quick program has several features that guarantee its uninterrupted operation:

- you can not set the duration of the program - time is always set to infinity,
- if the display fails, the program continues,
- after the power supply is resumed (after its failure), the program continues,
- to prevent the program from stopping accidentally, the STOP button was removed from the main window (Figure 14).

Figure 14 SMART program

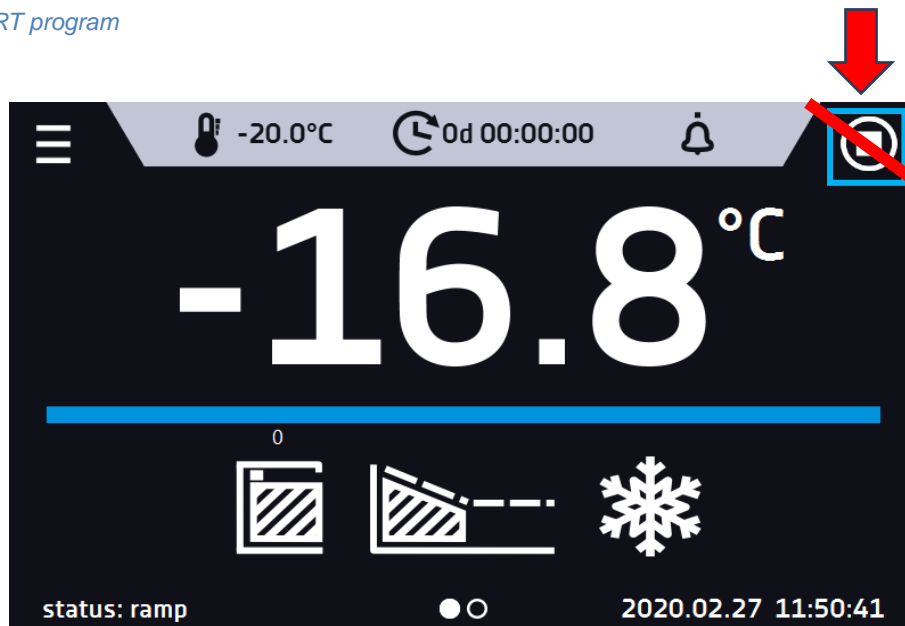

In order to go to Quick program click the icon  in the main screen. By clicking the appropriate icon you can set:

-  temperature (Figure 15),





Clicking the icon  starts the program in continuous mode (time set to infinity).

Figure 15 Starting the Quick Program



Stopping a Quick program has been made difficult on purpose (this prevents the program from being stopped accidentally) – to stop a program, you have to go to the menu , click the program window  and keep pressing STOP button  for 5 seconds.

After configuration of the Quick Program, it appears in the programs list (Figure 16). Quick Program is displayed at the top of the list by default.

Figure 16 Quick program on programs list

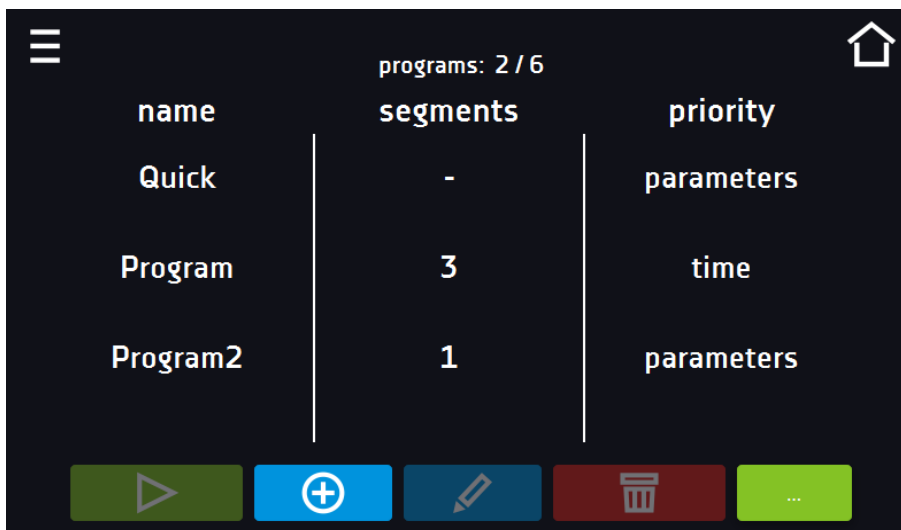

In Quick Program editing mode, you can change:

- settings of the data recording interval,
- settings of the protection class.

When the program is running you can change the temperature by pressing the icon . During next launch of the Quick program, your previous settings will be remembered.

6.5. Programs

Press the icon of main menu  and then press . In program panel (Figure 17) you can run the selected program, add a new one, edit the program or delete it. The user can create 5 independent programs.





-  Start the selected program.
-  Stop the program.
-  Add a new program.
-  Edit the selected program.
-  Delete the selected program.

Figure 17 List of programs



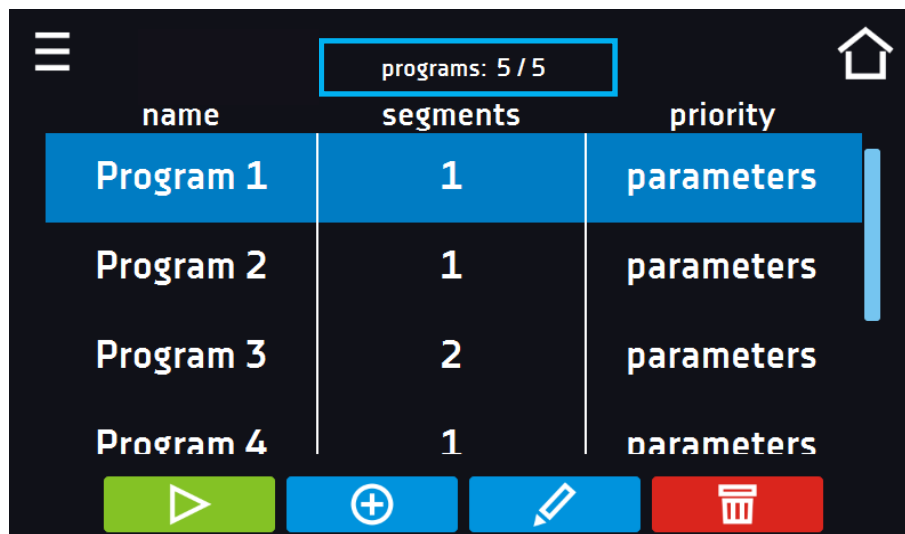

name	segments	priority
Program 1	1	parameters
Program 2	1	parameters
Program 3	2	parameters
Program 4	1	parameters

programs: 5 / 5

Information on the number of created programs / the maximum number of programs that can be created is at the top of the screen (programs: 5/5).

6.5.1. Creating / editing a program

Press the button  or  and a panel with program parameters will appear (Figure 18). The program name is given automatically and it can't be changed. In this panel you can set:

- **Segments number** – max. 6 segments
- **Interval** – frequency of saving the data in the data record (1 min, 2 min, 5 min, 10 min, 15 min, 30 min, 1 h),
- **Priority** – the priority of time or parameters, more information [Section 6.5.4.](#)
- **Loop** – the number of program repetitions, more information [Section 6.5.5.](#)

Figure 18 Program parameters

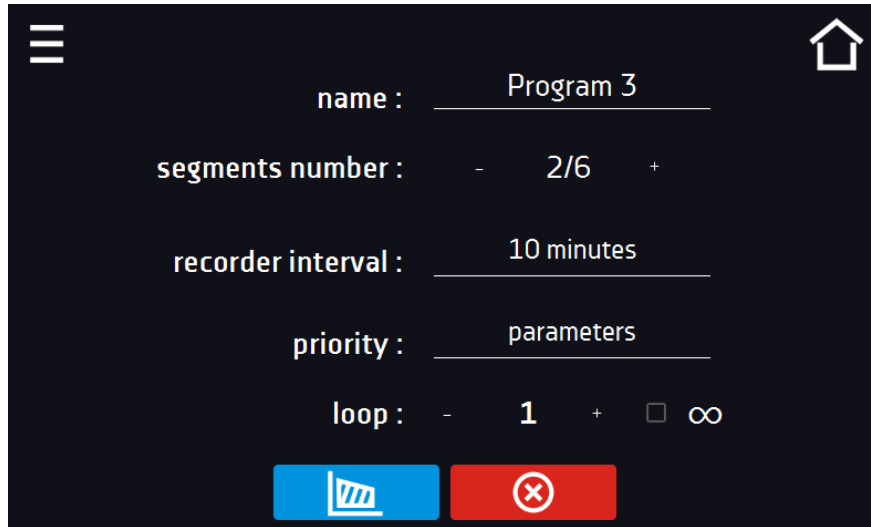

Cancels adding or editing of the program.



Going to the edition of program segments.



With more parameters, the window can be scrolled up and down.

6.5.2. Segments edition

For each of the 5 programs, you can set maximum 6-segment time-temperature profiles that allow you to gradually increase or decrease the incubation temperature of the samples. This can e.g. protect the sample from so-called thermal shock. Example of program operation with programmed segments (parameters priority):

Program 1 (for ZLN-T/ZLW-T)

- segment1: temp. -5°C, time 2 hours (after reaching the temperature -5°C, it is maintained for 2 hours)
- segment2: temp. -10°C, time 3 hours (after reaching the temperature -10°C, it is maintained for 3 hours)
- segment3: temp. -15°C, time 3 hours (after reaching the temperature -15°C, it is maintained for 3 hours)
- segment4: temp. -20°C, time 2 hours (after reaching the temperature -20°C, it is maintained for 2 hours)
- segment5: temp. -30°C, time 2 hours (after reaching the temperature -30°C, it is maintained for 2 hours)
- segment6: temp. -40°C, time ∞ (after reaching the temperature -40°C, it is maintained in continuous way)

Press the button  and the first program segment will appear (Figure 19).

In this window you can set:

- **temperature** – target temperature which the device is to achieve in this segment,
- **time** – the time of maintaining the set temperature ([d hh:mm]) in days, hours and minutes. It is possible to select continuous work ∞ in the last segment,
- **ramp time** – the time of reaching the set temperature ([d hh:mm]) in days, hours, minutes.

The active value is highlighted in blue. The item highlighted in red means that the value is out of range and you should enter another one, e.g. the temperature is above / below the operating range of the device or the protection temperature.



In ZLW-T 200 and ZLW-T 300 freezers the fan is set to 100% by default and cannot be changed.



Ramp time - setting a short time will not accelerate reaching the ramp, but the ramp will be reached in the shortest possible time depending on the set temperature, ambient conditions and the possibilities of the cooling system in the device.

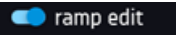

The ramp parameters are factory set in accordance with the manufacturer's instructions. If it is necessary to set individual parameters when reaching the segment temperature, activate the ramp edition field  and set your own values.

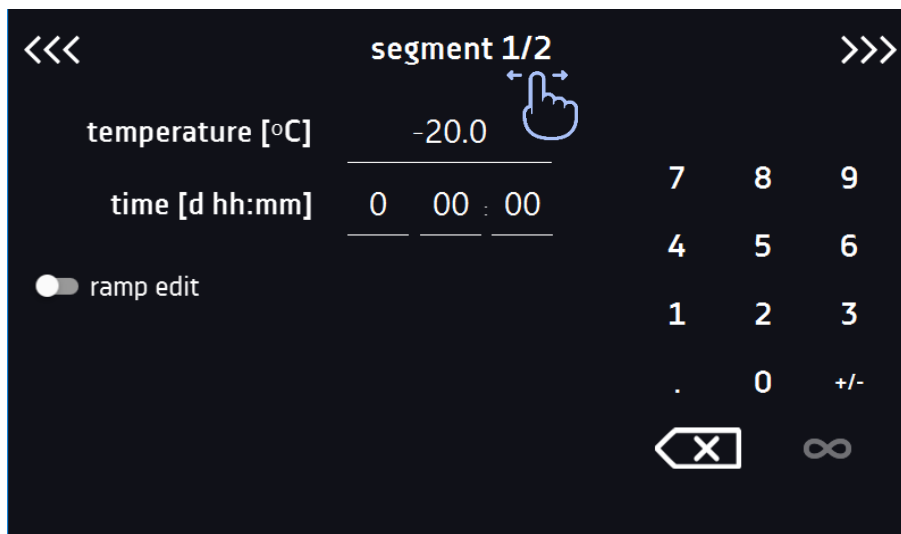

With more parameters, the window can be scrolled up and down.

Figure 19 Program segment edition



The navigation between: segments, program parameters and summary is done by touching the icon  .



If, when editing a program, you automatically return to the home screen, the edited program will not be lost, but saved as a draft (see below).

After configuring all segments, a window with the protection class is displayed (Figure 20). For 3.2 (option) you can set the protection temperature.

(Figure 20). Security class

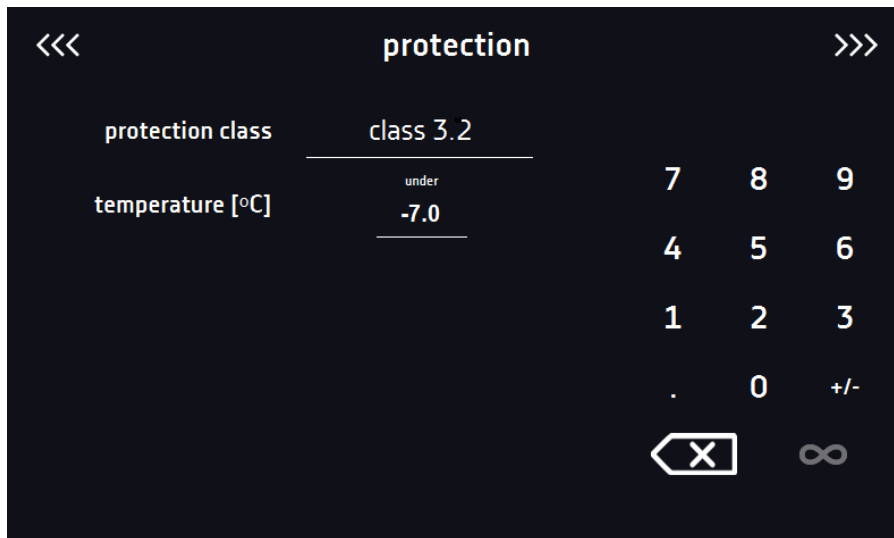

After switching to the program edition, the information about the possibility of continuing changes in the program settings appears (Figure 21).

Figure 21

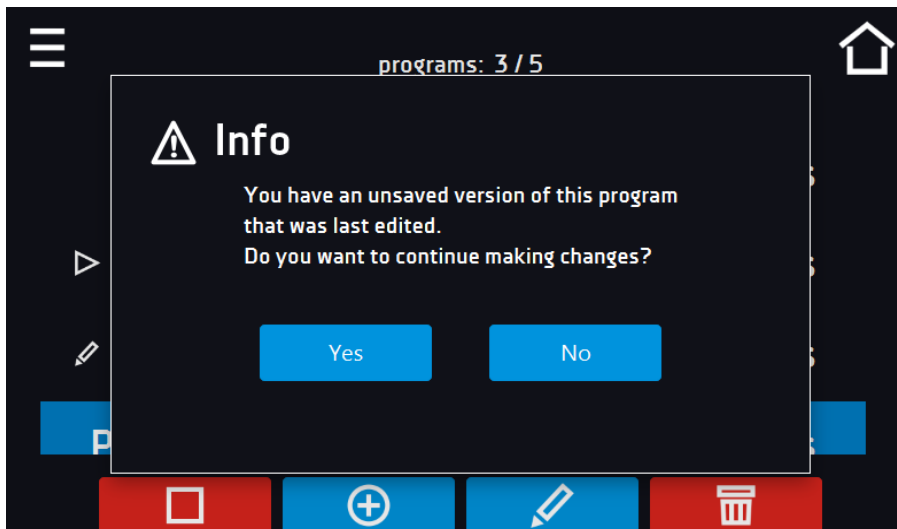

6.5.3. Summary of segments

In the segments summary (Figure 22) all segments can be seen along with introduced parameters:

- number of segments,
- temperature,
- duration time of the segment,
- target time of reaching temperature of a given segment.

Figure 22 The summary of the segment

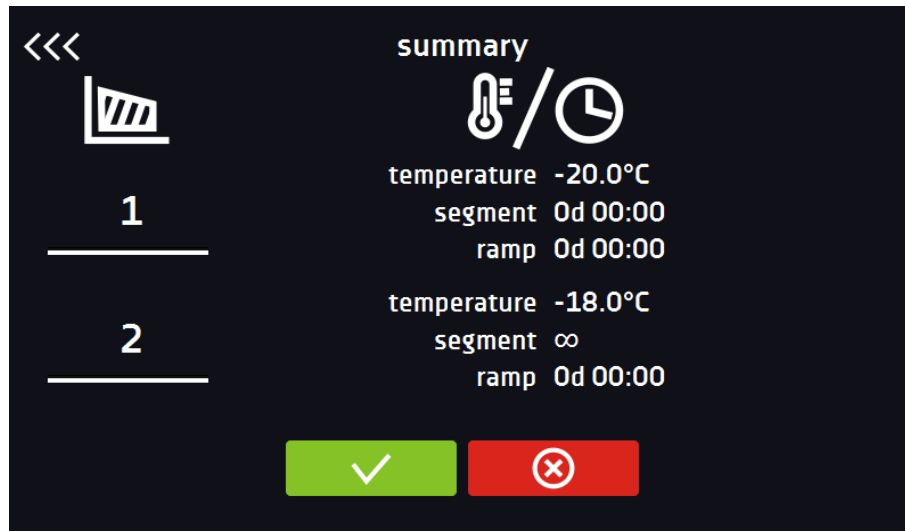

Confirms and saves the changes.



Cancels the entered changes in the segments and goes to program parameters.

6.5.4. Priority

Can be set in terms of:

Parameters:

In the program without ramp – the device starts the countdown of the segment time when the set temperature is reached.

In the program with ramp – first, the device counts down the time of the ramp and then proceeds to the segment countdown when the set temperature is reached. Regardless of whether the time of ramp elapsed.



It may happen that the device failed to reach the set temperature within the set time because the reaching time was too short. In such situation the reaching time will be prolonged and the segment's time countdown will start when the set temperature will be reached.

Time:

In the program without ramp – the device starts counting down the segment time when the program is started. Regardless of whether the temperature has been reached.

In the program with ramp – first, the device counts down the ramp time and after its expiry it proceeds to the countdown of the segment time. Regardless of whether the temperature has been reached.



It may happen that the time of reaching was too short and the device failed to reach the set temperature within the set time. Then the countdown of the segment time will start before reaching the set temperature. Thus, the actual time of device operating in the set temperature will be shortened.

6.5.5. Loop

The option is available if the number of segments is equal to 2 or more. When the program finishes the last segment, the device starts the program again from the first segment. You can define if the program should be carried out once (loop: 1) or multiple times (loop: 2 to 255). In order to set the program to be carried out continuously, tick the „∞” option. If the time of the last segment is set to infinity, it will be treated as infinite only in the last cycle. In other cycles it will be treated as 0.

Example:

Loop:3

segment1: temp. -10°C, time 2 h

segment2: temp. -30°C, time 2 h,

segment3: temp. -40°C, time „∞”

The device will run segment1 and segment2 three times and then will go to segment3 which will last indefinitely.

Due to the fact that laboratory freezers do not have a heating system, when switching from a lower to a higher temperature, the compressor turns off, and the temperature rises naturally, which greatly extends the cycle. The cycle duration can be determined empirically.

6.5.6. Defrosting of ZLN, ZLN-T, ZLN-UT VIP devices

During operation, a layer of ice may form inside the freezer's compartment. The speed of ice or frost formation depends on several factors: ambient conditions (temperature, humidity), how often the door is opened, and the type of samples. When an ice or frost layer covers the entire chamber, defrosting is necessary. **Defrosting** is performed manually in the following order:

1. turn off the device (unplug the power cable from the socket),
2. open the door and allow the device to defrost (do not accelerate the defrosting process),
3. wipe dry the water accumulating on the bottom and the walls of the chamber,
4. turn on the device (insert the power plug into the socket).

6.6. Starting the program

The created program can be started in two ways:

6.6.1. The first way



- Go to the main menu  and press the icon „programs”  (Figure 23).
- Then select the program you want to activate and press „start” button  (Figure 24).

Figure 23 Main menu

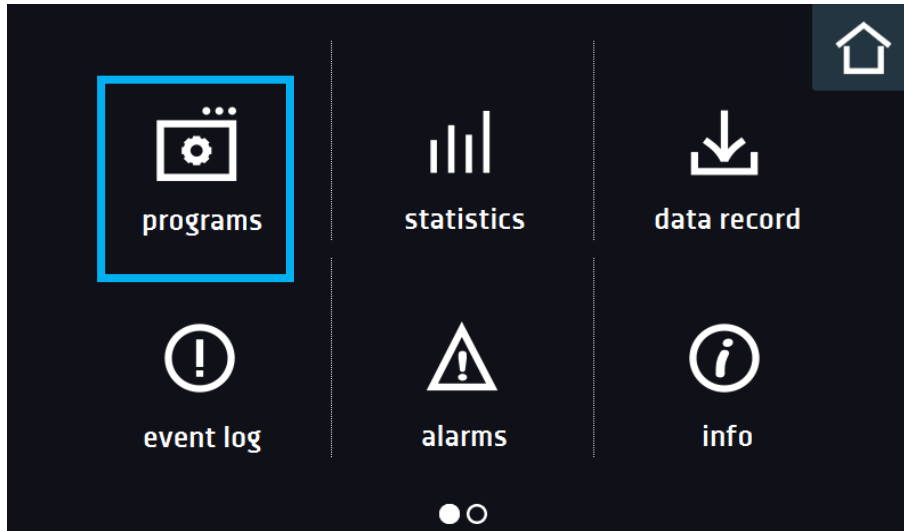

Figure 24 Program management menu

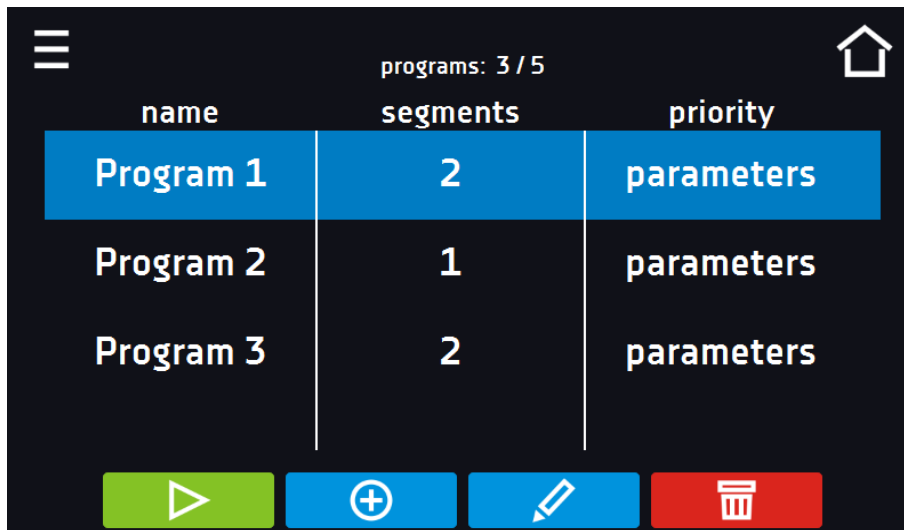
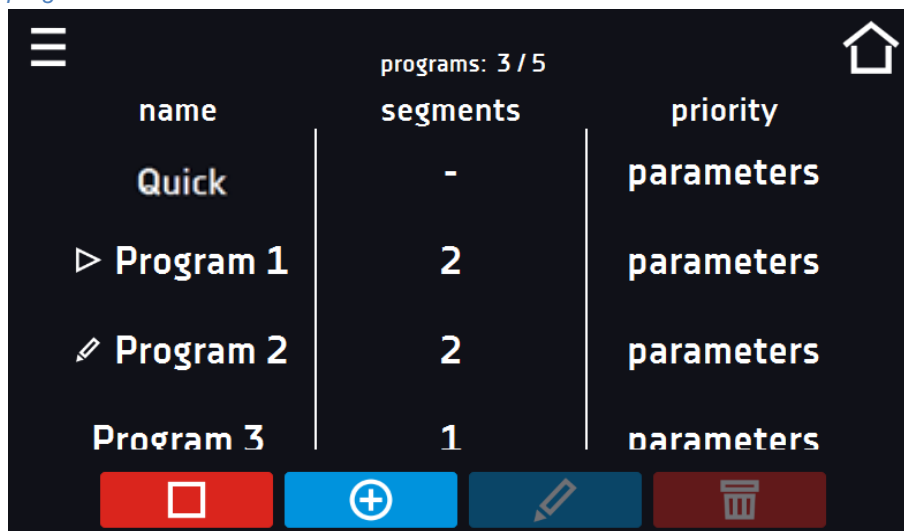



Figure 25 List of programs with the selected status



6.6.2. The second way

- In the main screen (Figure 26) press the icon in the upper right corner .
- Select the program you want to start (Figure 27). You have two additional options to start the program:



Immediate start of the program.



Scheduled program start according to the set date and time.

Figure 26 Main screen

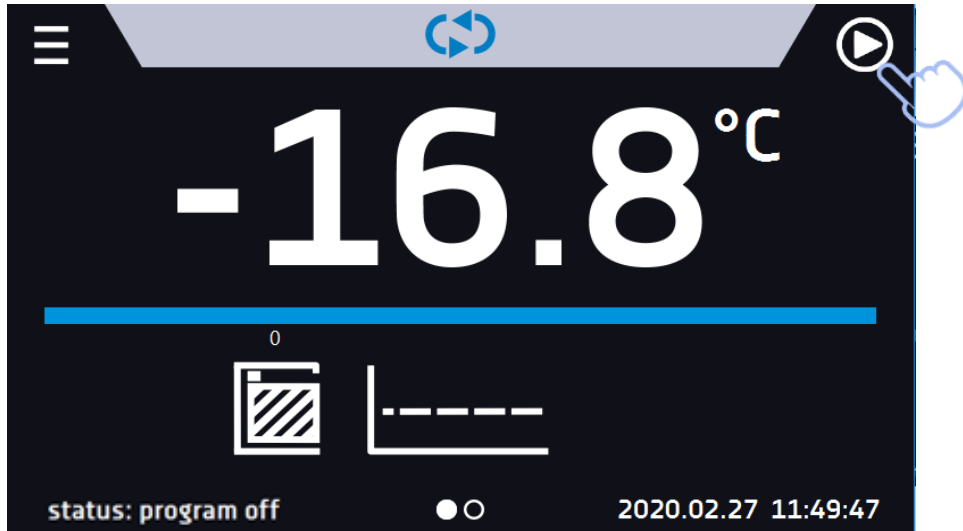

Figure 27 Selection and launch of the program

PROGRAM		
name	segments	priority
Program 1	2	parameters
Program 2	1	parameters



A delayed start of backdated program is possible (up to 7 days back). This is possible for the programs with time priority. Program segments that would last from the back date to the current date will be skipped.

If the program is running, the symbol  appears next to the program name on the list.

6.7. Quick Change of parameters



Although the ramp time has been included in the program, the Quick Change of parameters will take place immediately while the temperature is being reached.

6.7.1. Quick change of set temperature



In order to quickly change the value of set temperature of a running program, press the icon  in the main screen (Figure 28). The value of the temperature should be selected by scrolling the list up or down (Figure 29). Click  to confirm the change.

Figure 28 Quick change of set temperature - selection

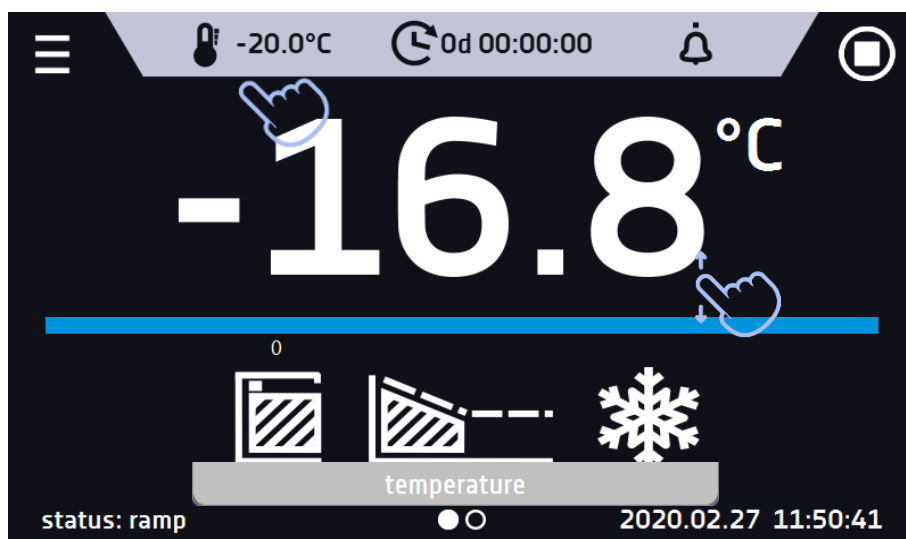
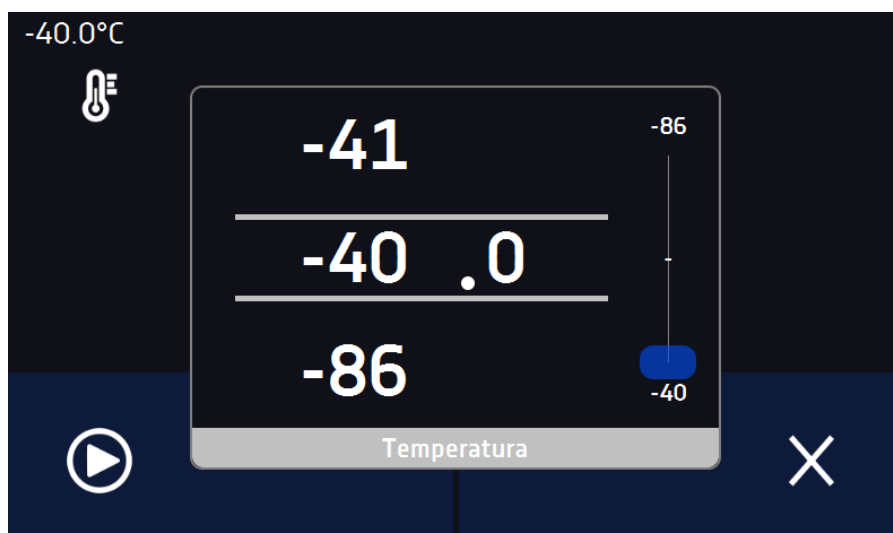





Figure 29 Quick change of set temperature - value setting



If the set temperature is higher than the current temperature inside the chamber, the compressor turns off and the device reaches the set temperature naturally (freezers do not have a heating system).

6.7.2. Quick change of set time

In order to quickly change the duration time of a running program, press the icon  in the main screen (Figure 30).

Select the number of days, hours and minutes by scrolling the list up or down (Figure 31). Click  to confirm the change. To set the continuous work press .

To change the way of displaying the time, press::

 – to display the elapsed time

 – to display the remaining time

To change only the way of displaying, you do not have to confirm it by .

Figure 30 Quick change of set time - selection

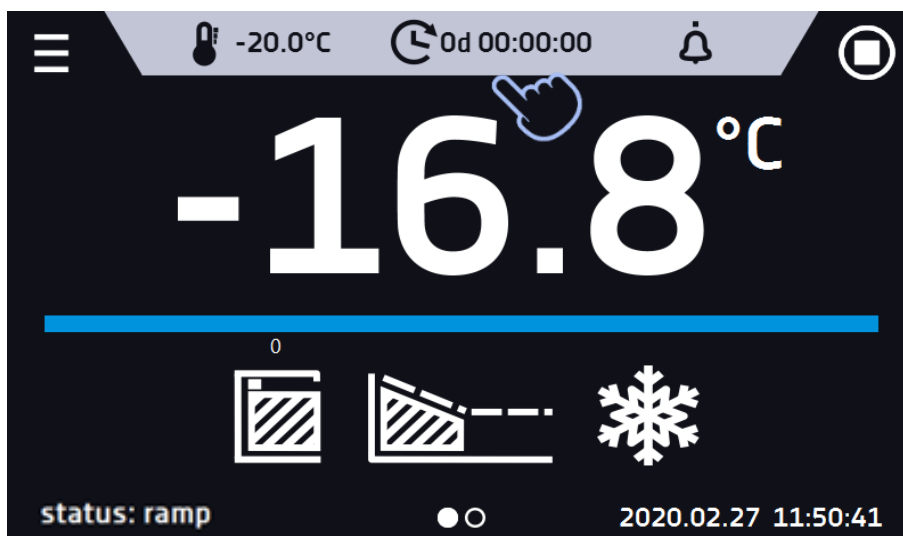
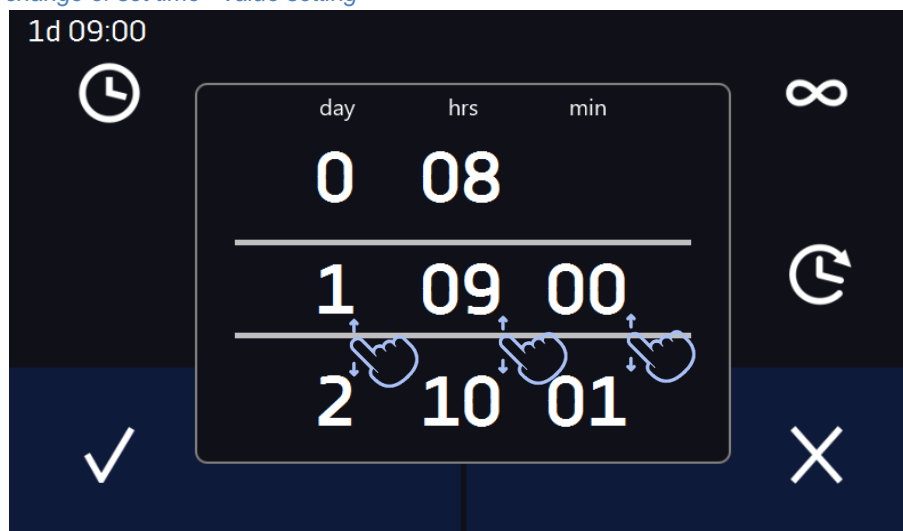



Figure 31 Quick change of set time - value setting



6.8. Statistics

Press the icon of the main menu  and then press . In this panel (Figure 32) statistics of the currently running program or program that has ended are displayed. Statistics are calculated separately for each segment. Data logging for calculation starts after 30 seconds from reaching the set temperature in the segment. Further data is registered every 1 minute.

The following information is available:

- **set temperature [°C]** – set temperature in the segment,
- **minimum temperature [°C]** – the lowest recorded temperature,
- **maximum temperature [°C]** – the highest recorded temperature,
- **average temperature [°C]** – average temperature,
- **segment** – status of the segment:
 - **in progress** – currently running segment (data is being constantly updated),
 - **finished** – the segment has been completed,
 - **interrupted** – the segment was interrupted by the user before the set time has elapsed,
- **segment 1/2** – the number of the currently overviewing segment / number of the currently performed or completed segment. Navigating between the segments is done by swiping your finger up or down.

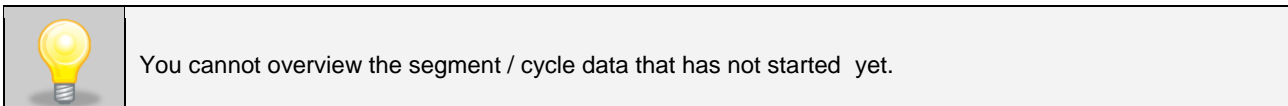
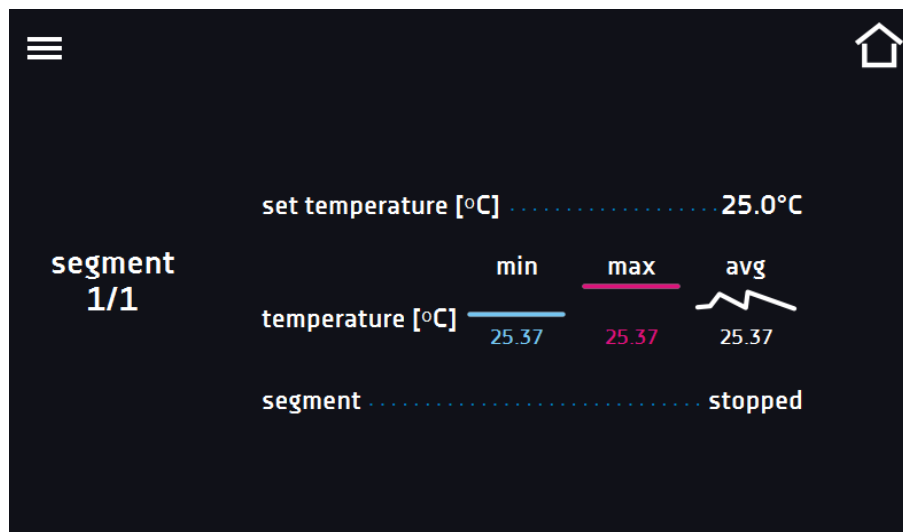

Figure 32 Statistics



6.9. Data record

Press the icon of the main menu  and then press . Data record window (Figure 33) contains the following information:

- time and date of sample registration [date],
- temperature value measured with the main sensor in the chamber [temp.].

Each user can register 10 000 data records for the max period of 6 months. If all the memory cells are full, the oldest ones are overwritten. The data appears in the table in the order they were added, not in chronological order by the date. The most recently added record is at the top. The samples are only registered when the program is running. The frequency of registration depends on the program parameters settings.



 When opening the data record, all data is downloaded. If the data download is interrupted by the user, press  to continue downloading of the rest of the data.

Figure 33 Data record



date	temp.	status
2020.11.11 09:13	24.65	set temp.
2020.11.11 09:12	24.65	set temp.
2020.11.11 09:11	24.65	set temp.
2020.11.11 09:10	24.65	set temp.
2020.11.11 09:09	24.65	set temp.
2020.11.11 09:08	24.65	ramp
2020.11.11 08:56	24.65	ramp
2020.11.11 08:46	24.65	ramp

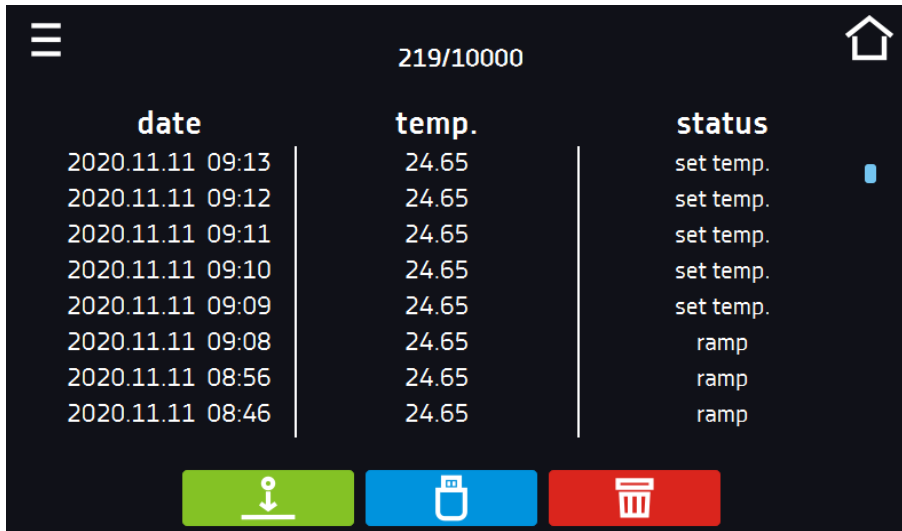

Press to continue downloading data.



Recording data onto the USB flash drive. .csv files are available - separated by semicolon when opening e.g. with a spreadsheet, .plx - opening with the Lab Desk application (option)



Before removing the USB flash drive from the USB port, it must be unmounted, see [Section 5.5](#).



Deleting data ([Figure 34](#))

Figure 34 Progress bar

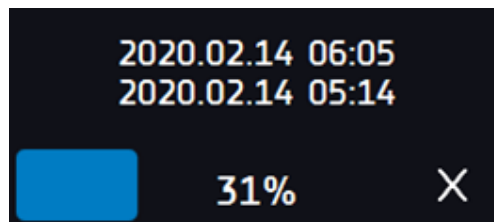
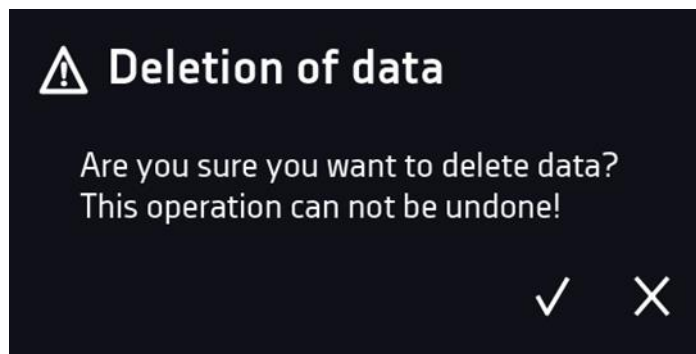

Figure 35 Deleting data









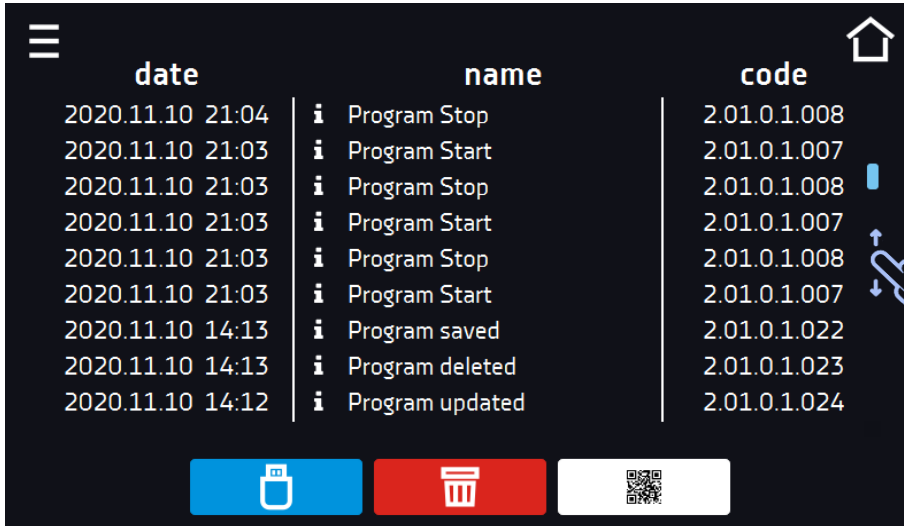

6.10. Event log

Press the icon of the main menu  and then press . This window displays information about registered events, alarms and errors.

Figure 36 Event log



date		name	code
2020.11.10 21:04		Program Stop	2.01.0.1.008
2020.11.10 21:03		Program Start	2.01.0.1.007
2020.11.10 21:03		Program Stop	2.01.0.1.008
2020.11.10 21:03		Program Start	2.01.0.1.007
2020.11.10 21:03		Program Stop	2.01.0.1.008
2020.11.10 21:03		Program Start	2.01.0.1.007
2020.11.10 14:13		Program saved	2.01.0.1.022
2020.11.10 14:13		Program deleted	2.01.0.1.023
2020.11.10 14:12		Program updated	2.01.0.1.024



Recording data onto the USB flash drive. .csv files are available - separated by semicolon when opening e.g. with a spreadsheet, .plx - opening with the LabDesk application (option)



Before removing the USB flash drive from the USB port, it must be unmounted, see [Section 5.5](#).



Deleting data



QR code – opens smart4lab.eu (in the "Support" tab there are explanations of some of the

information appearing in the event log). Press the symbol  and enlarge the code QR, and then scan it with your smartphone

Figure 37 QR code



The events in the event log are sorted chronologically. However, it may happen that the event "Program restarted" will not be displayed according to the chronology but the date and time of the event will be correct. This is not an error.

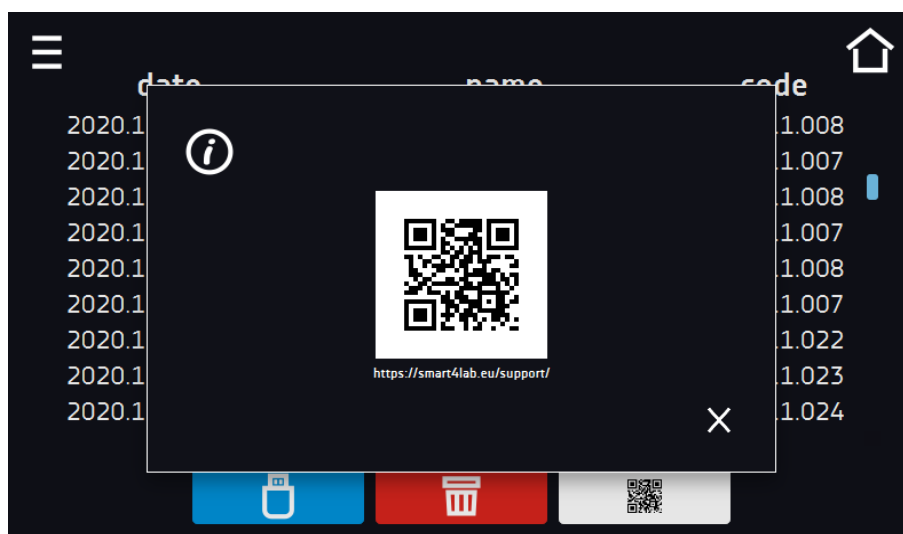

Before removing the USB flash drive from the USB port, it must be unmounted, see [Section 5.5](#).

Information signs in the event log:

-  Information event
-  Alarm event
-  Error
-  Warning

Possible events:

Program Start	starting the program
Program Stop	stopping the program
Program Edit	changing the program parameters
Program End	program is completed
DeviceOn	the device is switched on (on the main switch)
DeviceOff	the device is switched off (on the main switch)
Door opened	the door is opened
Open door alarm start	open door alarm has been activated
Door closed	the door is closed
Open door alarm stop	open door alarm has been deactivated
Program Restarted	program has been resumed after power failure
Date/time change	date/time has been changed
Lower temp. alarm Start	activation of the alarm of exceeding the temperature below the set temperature
Lower temp. alarm End	deactivation of the alarm of exceeding the temperature below the set temperature
Upper temp. alarm Start	activation of the alarm of exceeding the temperature above the set temperature
Upper temp. alarm End	deactivation of the alarm of exceeding the temperature above the set temperature
Program saved	new program has been saved
Program deleted	program has been deleted
Program updated	program has been updated
Time Zone Changed	in the time settings the time zone has been changed
Temperature Correction Changed	main sensor temperature correction has been changed
Emergency stop of the program	the program has been automatically stopped – there was a situation that didn't allow the program to be continued. PLEASE CONTACT THE SERVICE
Defrosting Start	starting the defrosting process
Defrosting Stop	stopping the defrosting process
Power Fail Start	power failure / device fuse blown out.
Power Fail Stop	power resumed, returned to maintain program parameters



6.11. Info

Press the icon of the main menu  and then press . The panel contains the following information:

- name of device,
- serial number,
- temperature range,
- Software version,
- manufacturer's address,
- manufacturer's website,
- QR code.

Figure 38 Info window (example)





Press icon  to save the “Download” folder (with instruction manual) on the USB flash drive. After inserting the flash drive into USB port wait few seconds until the information “Flashdrive connected” will appear on the display - for more information go to the [Section 6.1](#). Press the icon  to write the service data on the USB flash drive – contact the service department for more information.



Press  to go to the main screen.



Before removing the USB flash drive from the USB port, it must be unmounted, see [Section 5.5](#).

6.12. User settings panel

Press the icon of the main menu  and then press . In this panel ([Figure 39](#)) you can:

	Change the name of the equipment – by default, the device serial number is entered.
 English	Change the language in the equipment's menu.





	Set the time after which the screen will be dimmed.
	Turn on/off the sound . Critical alarms will continue emitting a sound.
	Set the time after which the user will return to the home screen. Available settings: off, 1 min, 3 min, 5 min, 10 min.
	Set the automatic screen lock. Available settings: off, 5 min, 15 min, 30 min, 60 min. Factory setting: disabled.

Figure 39 User settings panel 



Confirms changes



Cancel the entered changes



6.12.1. **Unlocking the touch screen**

When the automatic touch screen lock is enabled ([Section 6.16](#)), slide the blue circle into the white circle to unlock the screen.

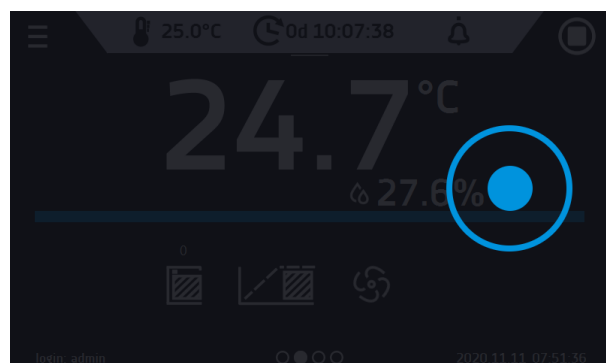
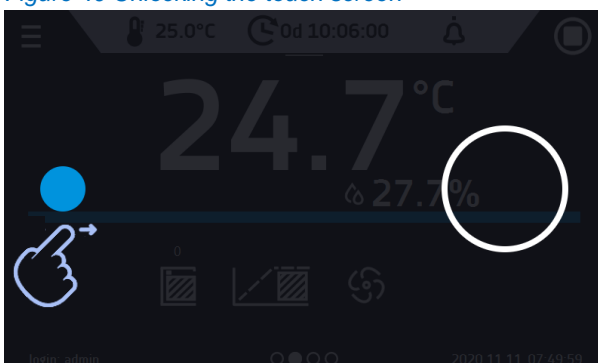
Figure 40 Unlocking the touch screen



6.13. Time

Press the icon of the main menu  and then press . In this panel you can:

- change the date / system time. After changing the date / system time the device will be restarted.



If the date / system time is changed to the later date / time comparing with the data and events which are stored in the memory, they will remain in the register. If the date / system time is changed to the earlier date than the date / time which is stored in the memory, they will be transferred to the archive

- change time zone - the change of time zone will not affect the date / time in data and events previously saved.

To change the date / system time it is necessary to press  in the window (Figure 41). The window will appear and you will be able to make changes (Figure 42).

Figure 41 Time zone change

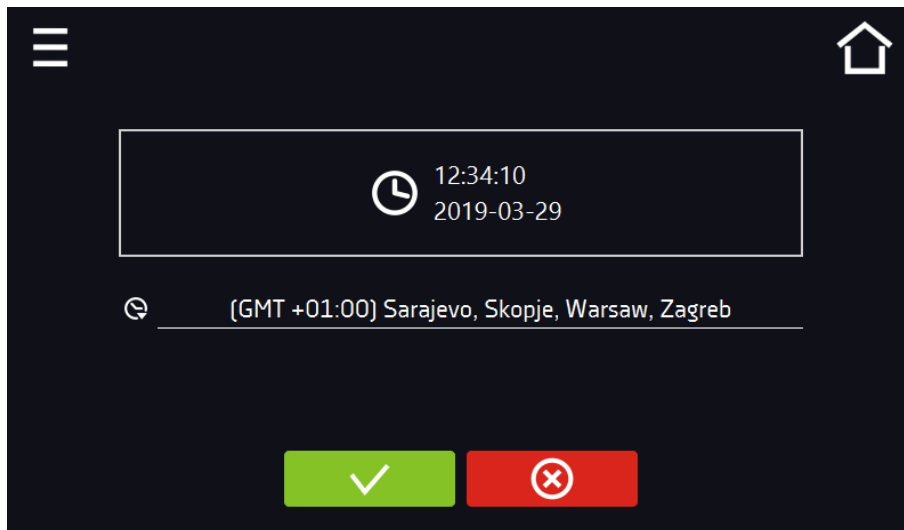
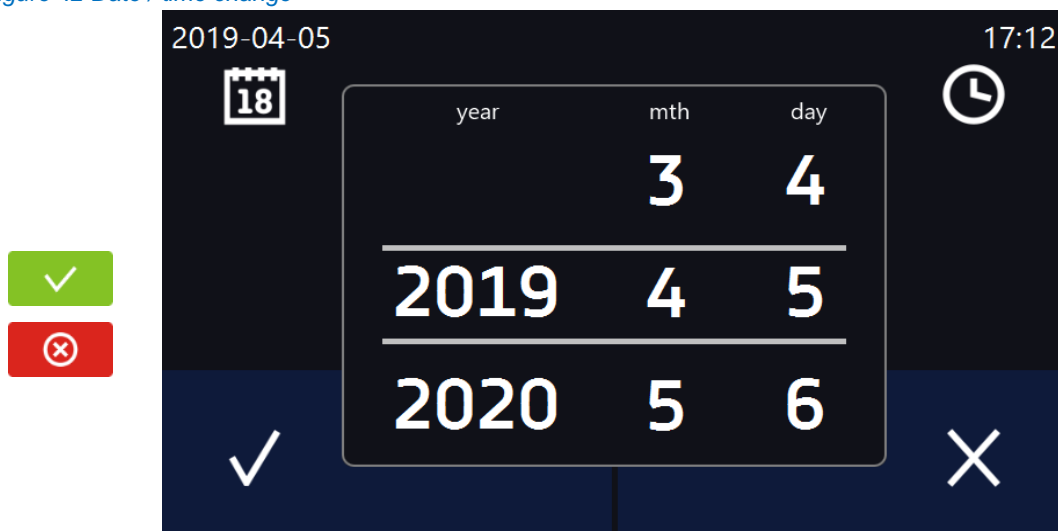

Figure 42 Date / time change





The same time zones are required for the programs to work properly on the device and on the computer.

6.14. Alarms

6.14.1. Alarms when set parameters are exceeded

Press the main menu icon , and then press . Here you can set parameters related to alarms

- **low alarm** – an alarm will be generated if the temperature drops below the set value by the value specified in this field,
- **high alarm** – an alarm will be generated if the temperature increases above the set value by the value specified in this field.



In the "lower alarm" field you can enter a value from the range of -0.5°C to -5°C, and in the "upper alarm" field from the range of 0.5°C to 5°C.

Figure 43. Parameter exceedance alarms

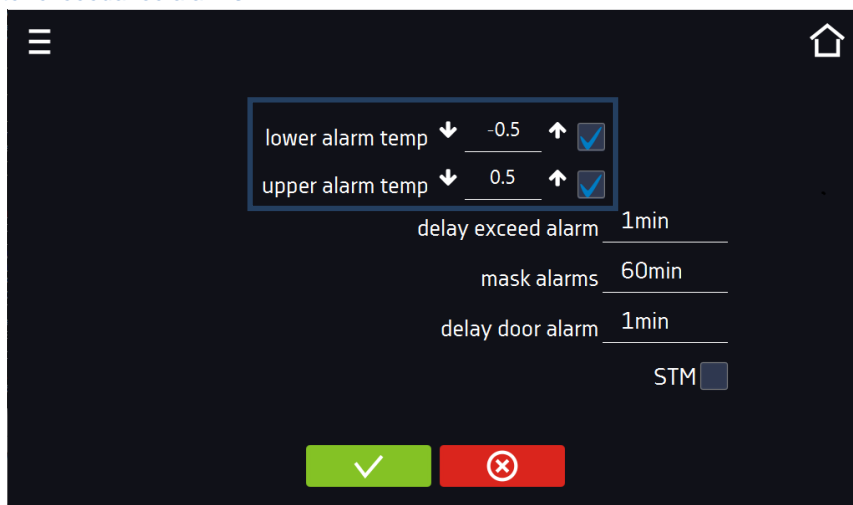

Confirm the changes.



Cancel the entered changes.

The upper and lower alarms can only be generated when the set temperature is reached.

- **temperature alarm delay:**
the alarm will be activated with a delay (1 min, 2 min, 5 min, 10 min, 15 min) after exceeding the permitted temperature.

6.14.1.1. Masking of parameter exceedance alarms

Masking of alarms when the set parameters are exceeded can be used when new samples are added to the chamber or samples are added to those already incubated. During these activities, the set parameters, i.e. temperature, may be exceeded and alarms may be activated - parameter exceedance alarms are set assuming that stable conditions prevail in the chamber (temperature) and the door is closed. After opening the door and placing the samples in the chamber,

time is needed for the parameters to stabilize - the alarm masking function allows you to delay alarms when the parameters are exceeded.

The parameter exceedance alarm will be triggered with a delay (15 min, 30 min, 45 min, 60 min, 120 min, 150 min, 180 min) after inserting new samples. The time is counted from the last time the door was opened. Setting 0 s means masking is disabled.



If the door is opened during the parameter exceedance alarm, the ongoing alarm will not be "masked". Only the next alarm can be masked.

Figure 44. Alarm masking

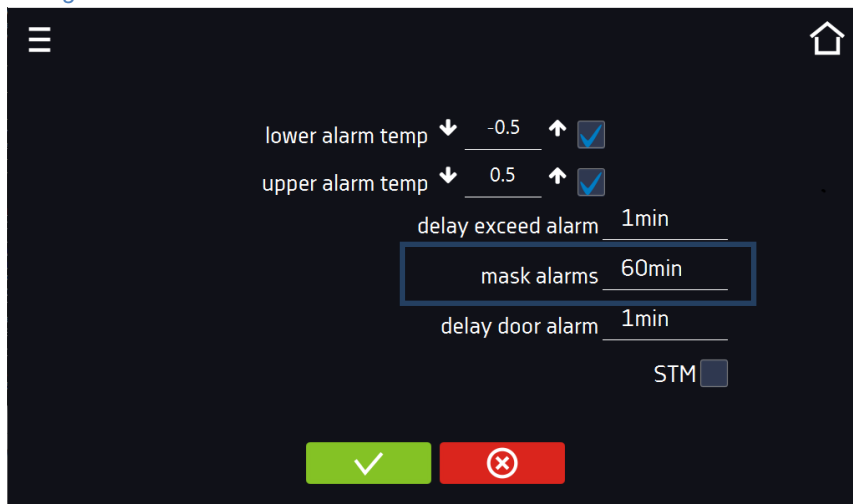

Confirm the changes.



Cancel the entered changes.

Figure 45 Alarm masking enabled

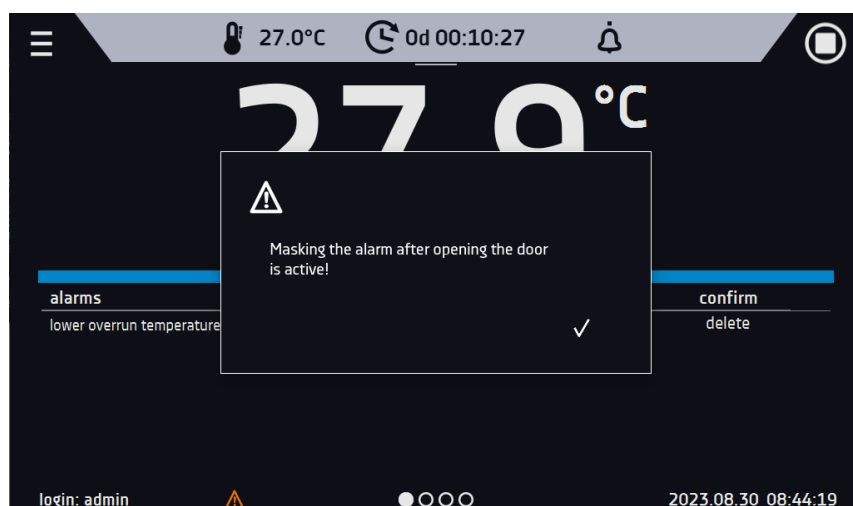

6.14.2. Open door alarm

All devices are equipped with an open door sensor. If the door is left open longer than the time set by the user, an acoustic signal, a red flashing alarm bar and a "door open" alarm with the status "active" will appear.

- door open alarm delay:

The door alarm will sound when the door is open for the user-selected time (30 sec, 1 min, 2 min, 5 min, 10 min).

Figure 45. Open door alarm delay

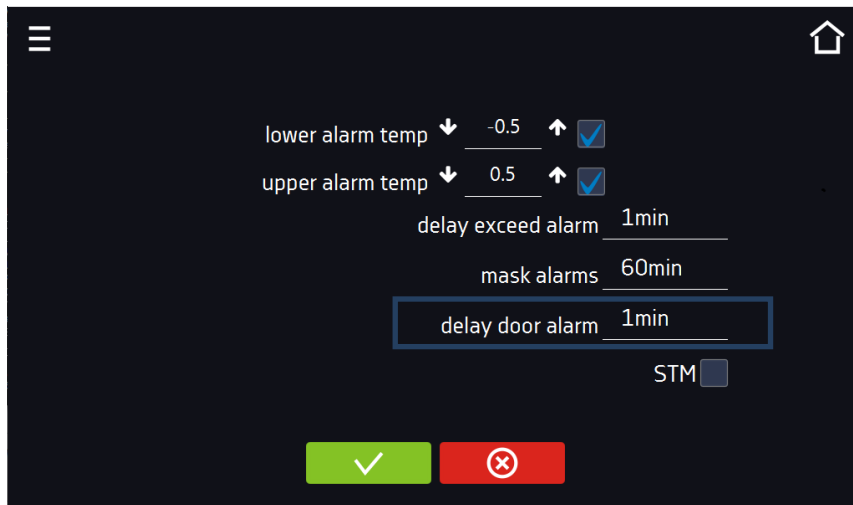

Confirm the changes.



Cancel the entered changes.

6.14.3. STM function

The STM (Smart Temperature Monitor) function informs the user if there is a problem in reaching or maintaining the set temperature. The user can enable/disable the function (Fig.70).

If the STM function is enabled, the STM symbol will appear on the screen next to the temperature of the main sensor.

Figure 46. Enable/disable STM function

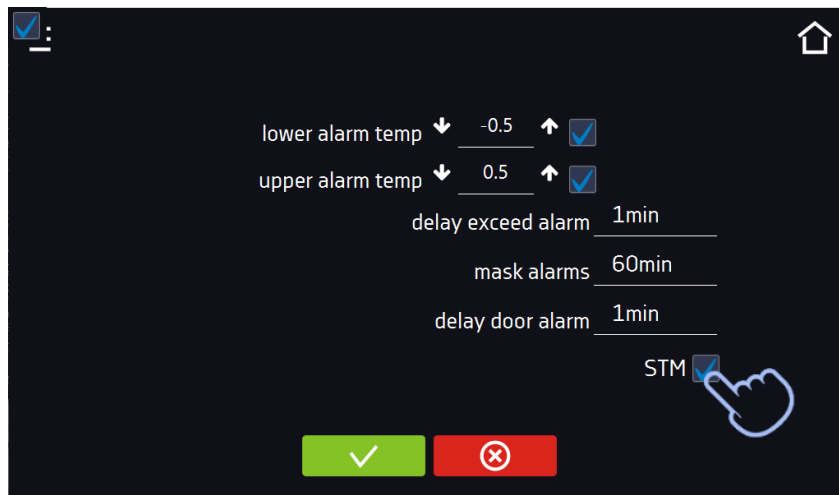

Confirm the changes.



Cancel the entered changes.

The function status is indicated by color:

- no inscription – option disabled,
- white color – option enabled, program is stopped (Fig. 71),
- blue color – option enabled (temperature monitoring), program running (Fig. 72),
- red color – option enabled, warning about problems with achieving/maintaining temperature (Fig. 73).

Figure 47.



Figure 48.



Figure 49.



Possible causes of operation:

1. damaged heater,
2. the cartridge inserted into the chamber absorbs / releases too much energy.

If the color was red before opening the door, then the color changes to blue after opening the door.

If the function is activated (detection of problems with achieving/maintaining temperature):

- the warning 4.00.0.1.009... appears in the event log.
- the color of the STM inscription changes to red and remains red throughout the disruption, segment change, and program shutdown.
- when the state changes from red to blue, an entry about the end of function 4.00.0.1.010 appears in the event log.

6.14.4. Mute option

The icon  in the main screen in the upper menu allows temporary switching off of the alarms sound (open door alarm, exceeding temperature range), e.g. to avoid door alarm during planned loading of the samples into the chamber. There are options to turn off the sound for 5, 10 and 15 minutes ([Figure 50](#)), however, the sounds of critical alarms (e.g. damage to the temperature sensor, under-temperature protection - optionally) will be still emitted.

Figure 50 Mute function



6.15. Network

Press the icon of the main menu  and then press . In this panel ([Figure 51](#)) you can change LAN settings:

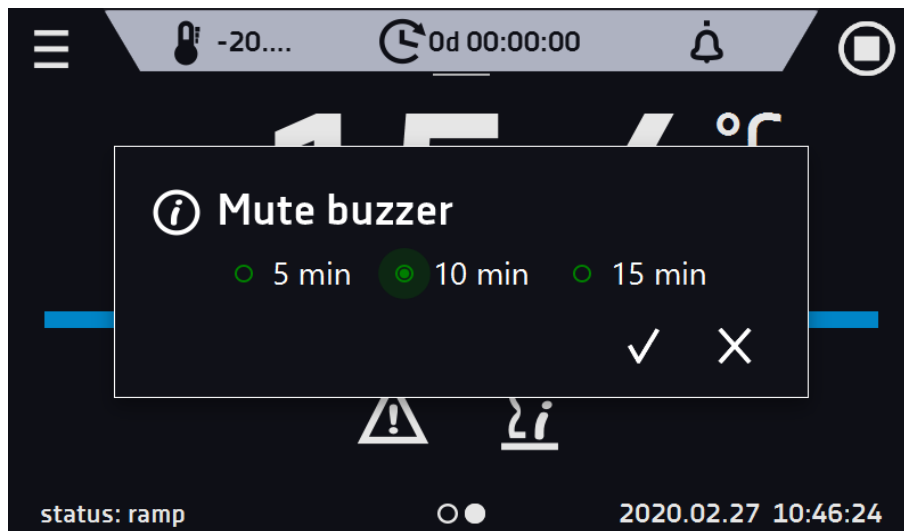
- **IP** – the device's IP address
- **Mask** – an Ethernet network mask to which the device is connected
- **Gate** – Server's IP address or router's that manages the Ethernet network
- **DNS** – IP address of the domain name system
- **MAC** – the address of the network card, read-only
- **DHCP** – you can select if the server that allocates IP addresses is running on the local network. You can then skip setting IP, Masks, Gates

Icon **A** indicates the connection status:



Device connected to the network



Device disconnected from the network

Figure 51 – LAN settings

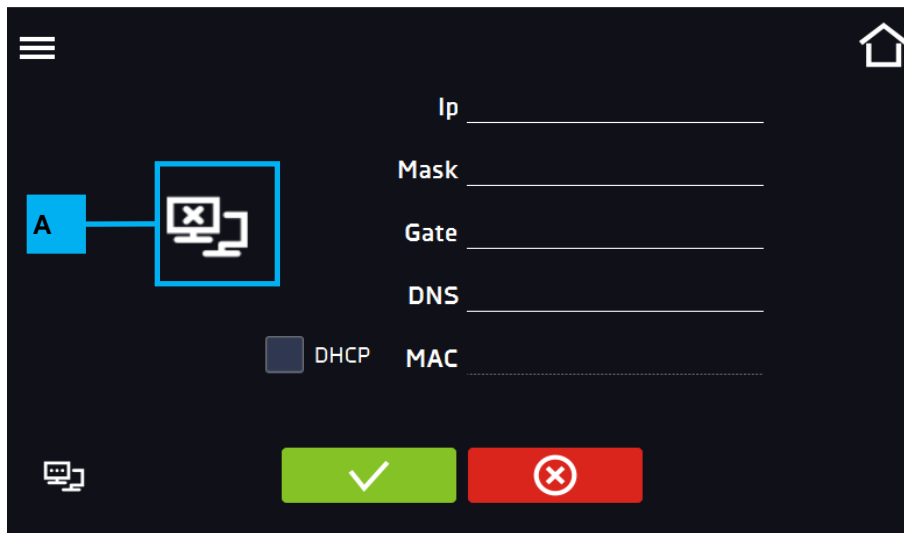



Confirms changes





Cancels the entered changes

6.16. Automatic defrosting function (standard for ZLW-T)

Press the icon of the main menu  and then press . In this panel (Figure 52) you can control the defrosting of the interior of the device. This is a standard equipment for the freezers with forced air convection: ZLW-T 200 and ZLW-T 300. ZLW units are additionally equipped with evaporator temperature measurement and heating of the condensate drain system. Defrosting has additional parameters to set:

- **preheat time of the tray [s]** - time before defrosting during which the condensate drain system should be preheated,
- **evaporator temperature [°C]** – temperature (on the evaporator) for the end of defrosting. Defrosting ends when the evaporator reaches the set temperature or after the time set in the **time** parameter has elapsed, depending on what occurs first.

 Default settings - 2 minutes defrosting every 2 hours, causes a temporary increase in temperature in the chamber. Defrosting parameters can be changed by the User depending on the application - test type (wet / dry), door opening frequency, etc.

 User can set parameters such as: **time, preheat time of the tray, evaporator temperature.** CAUTION: too low values may cause that the accumulated ice will not melt during the defrost cycle, which may result in increased icing. However, higher values can cause an unnecessary increase of the temperature in the chamber.

Pressing the button **DEFAULT SETTINGS** – restores the default defrost settings (period [h]: 2, time [s]: 120, delay [m]: 0, preheat time [s]: 90, evaporator temperature [°C]: 0.

NOTE: the option  must be selected.

Figure 52 Defrosting program

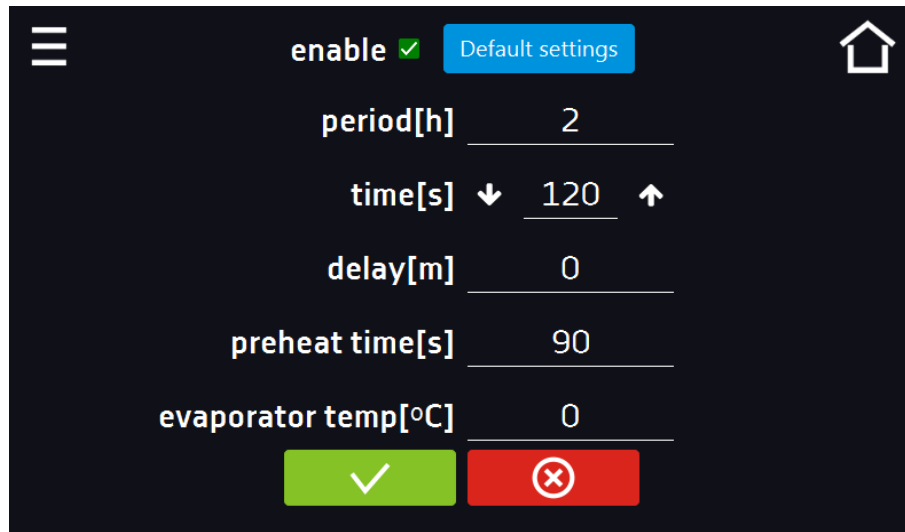



Confirms changes



Cancels the entered changes

6.17. Corrections

Press the icon of the main menu  and then press . In this window (Figure 53) you can correct temperature value indicated on the display by adding the correction value. The set correction value applies to the whole temperature range of the device. For example, if the average temperature displayed by the device indicates $-20,0^{\circ}\text{C}$ and the average temperature measured by independent, external sensor indicates $-20,5^{\circ}\text{C}$, the correction should be set on $-0,5^{\circ}\text{C}$. The average temperature should be calculated from chosen period of time e.g. 30 min. The correction available range is between -5°C to $+5^{\circ}\text{C}$.



The device has been calibrated by the manufacturer in accordance with applicable norms. The temperature shown on the display corresponds with a great accuracy to the temperature near chamber's sensor. For the correct operation of the device it is not necessary to use user's calibration. The user is performing temperature correction **on his own responsibility** and must be aware of consequences of changing manufacturer's settings. If the equipment was calibrated, calibration certificate **loses its validity**.

Figure 53 User's correction

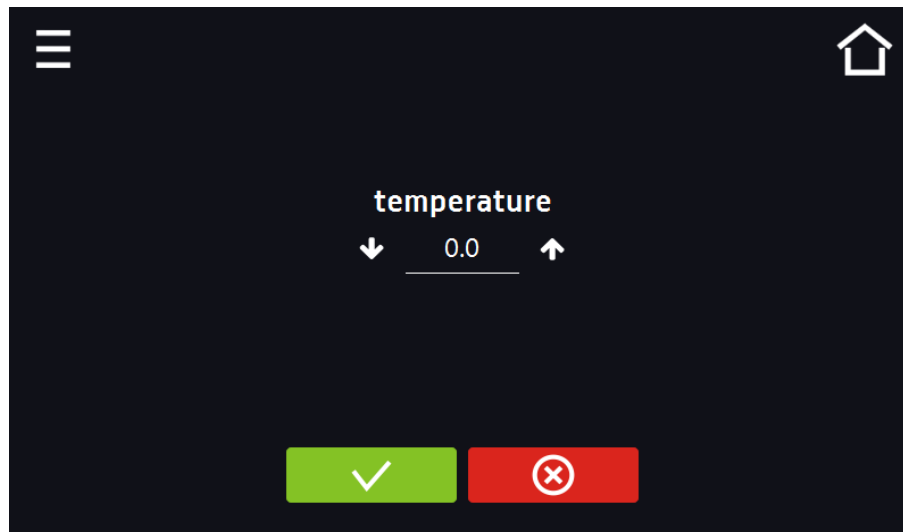

Confirms changes



Cancels the entered changes

7. INTERFACE

7.1. MODBUS TCP

The device allows status monitoring using the MODBUS TCP communication interface.

Connection parameters:

- IP address: same as device's (set in the panel [Section 6.15.](#))
- port: 502

register INPUT REGISTERS			
function READ_INPUT_REGISTERS (0x30001)			
Address	Type	Multiplier	Description
0	int	10	temperature from the main sensor
3	bool	-	Open door
4	bit	-	b0 – door alarm b1 – upper temperature alarm b2 – lower temperature alarm b5 – main sensor error b8 – temperature sensors error b10 – hardware error b11 – MRW error

8. CO₂ BACK-UP SYSTEM (OPTIONALLY FOR ZLN-UT VIP)

The CO₂ back-up emergency power supply system provides protection against temperature rise in the freezer's chamber and maintains a safe temperature of the samples in the event of a power outage. The operating range for the CO₂ back up system is above -70°C and results from the physical properties of carbon dioxide. An increase of temperature above 10°C from the set temperature and loss of power supply causes the dosing of liquid CO₂ to the chamber. The cylinder connected to the CO₂ back up system must be a siphon, thanks to which the gas in the liquid phase enters the

freezer's chamber, where it is released. The phase change cools down and keeps the temperature low. Gas dosing is carried out by opening a solenoid valve powered from a buffer battery. The decompression valve on the back of the device balances the pressure with the surroundings. The dosing of gas and the opening of the decompression valve causes an increase in noise. The amount of dispensed liquid CO₂ is regulated by a microprocessor controller. If the chamber door is open during CO₂ dosing, the gas will be automatically cut off.

Time of temperature maintenance by CO₂ back-up system depends on:

- capacity of CO₂ cylinder,
- ambient temperature,
- type and temperature of samples at the moment of power failure,
- degree of freezer filling.

Theoretically, a full 50l high-pressure cylinder is enough for 8 hours of CO₂ back-up operation in the ZLN-UT 300 VIP freezer (set temp. -80°C).



- **During the operation of the CO₂ back-up emergency power supply system, a significant amount of CO₂ enters the room, which in high concentration can be life-threatening. The device does not emit CO₂ when working with the power supply switched on.**
- **The CO₂ back-up system can't be operated near concentrated acids or corrosive vapors.**
- **The key to turn off the CO₂ back-up emergency power supply system must always be in an easily accessible place.**
- **The workplace must be properly ventilated!**

8.1. Indications for using pressure cylinders



The liquid CO₂ pressure cylinder is NOT supplied with the freezer with CO₂ backup system. The purchase, transport and connection is the responsibility of the user.

- Together with a pressure cylinder with compressed or liquefied gas, the user should be given a safety data sheet for the gas and instructions for its use.
- The ventilation performance in the room must ensure levels of gas concentrations in the rooms below the limit values.
- Opening the pressure cylinder valves is only permitted if the cylinders have been connected to the receiving installation first.
- During gas intake from the gas cylinder, check the pressure level regularly.

8.1.1. Characteristics of carbon dioxide

Carbon dioxide (CO₂) is a colorless, odorless, non-flammable and slightly acidic liquid gas. CO₂ is heavier than air and soluble in water.

Warning signs on the bottle containing CO₂



Non-flammable and non-toxic gases



Pressurised gas

Product ID: Carbon dioxide (100%)

Chemical formula: CO₂

Application of the substance: General industrial applications



Supplying gases other than CO₂ to the freezer is UNACCEPTABLE.



8.1.2. Hazards when working with CO₂

1. The bottle contains compressed gas that may cause cryogenic burns or injury (extremely cold liquid and high pressure gas).
2. Carbon dioxide in elevated concentration causes shortness of breath, circulation problems and ultimately death. Avoid breathing gas.

8.1.3. Personal protection

1) Hand protection

Wear loose fitting thermal-insulated gloves or gloves for handling cryogenic liquids. Norm EN 511 - protective gloves against the cold.

2) Eye or face protection

Wearing safety glasses is recommended when working with the bottle. Protect eyes, face and skin from splashes of liquid. Use safety goggles and face shield when reloading the product or disconnecting the transmission connections. Norm EN 166 – Personal eye protection.

3) Skin and body protection

Never touch with exposed body parts uninsulated elements of the CO₂ backup system. Extremely cold metal can cause the body to stick quickly and to damage it (detach) when attempting to retract.

4) Respiratory protection

In an atmosphere where there is a lack of oxygen (excess of carbon dioxide), use a self-contained breathing apparatus or a face mask with a positive pressure air supply. Respirators with air filters will not provide protection.

8.1.4. Control devices

To prevent the accumulation of gas above the permissible concentrations in the room, natural or mechanical ventilation should be provided. In addition, a natural or mechanical installation must be provided to prevent the oxygen concentration from falling below 19.5%.

According to the recommendations, the highest acceptable concentration of CO₂, that affects an employee during the 8-hour daily and average weekly working time specified in the Labor Code is: **9000mg / m³**. Maximum permissible instantaneous concentration: **27,000mg / m³**



It is recommended to use control and measurement equipment for measuring CO₂ concentration in rooms with a CO₂ backup system.

8.1.5. First aid

Contact with eyes: In case of contact with eyes, rinse them immediately with plenty of water and seek medical advice. Keep eye wide open while rinsing.

Skin contact: In the event of frostbite, seek medical assistance immediately. Whenever possible, immerse the affected area in a warm bath not exceeding 40°C (105°F). Do not rub frostbitten parts of the body as it may cause tissue damage. Apply a sterile dressing to the wound.

Inhalation: Move the victim to fresh air. CO₂ gas is heavier than air and accumulates e.g. at the floor. If breathing has stopped or is difficult, give aided respiration. Oxygen administration may be indicated. In the event of cardiac arrest, a trained person should immediately begin cardiopulmonary resuscitation.

in life-threatening emergencies:

- 1) protect yourself with a breathing apparatus,
- 2) remove the victim from the contaminated area,
- 3) call a doctor,
- 4) start CPR.

In the event of a gas leak:

Leave the room immediately, warn other people and ventilate the room if possible.

Emergency shutdown of the CO₂ back-up system:

- 1) close the gas cylinder valve,
- 2) turn off the freezer by turning the rotary switch on the front panel of the device to the OFF position (*Figure 54*).

Figure 54 Rotary switch



8.2. User's responsibility

The user is obliged to:

- 1) be familiar and comply with applicable health and safety rules, regulations and to train operators properly,
- 2) secure the device against access by unauthorized persons,
- 3) keep the device in perfect condition,
- 4) follow the maintenance schedule,
- 5) ensure that operators use appropriate personal protective equipment,
- 6) share the user manual and CO₂ safety data sheet with operators working with the freezer.

8.3. Emergency shutdown of the CO₂ back-up system

In each ZLN-UT VIP ultra-low freezer at the front in the bottom there is an emergency switch ([Figure 55](#)) for emergency temperature maintenance system.

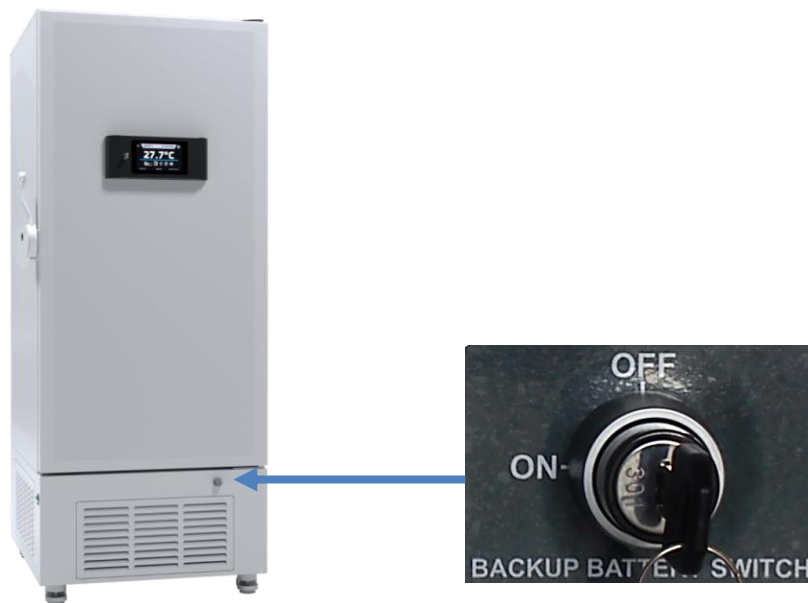

8.4. Connecting the freezer to a CO₂ cylinder

The CO₂ back-up system is located in the rear of the equipment (on the back).

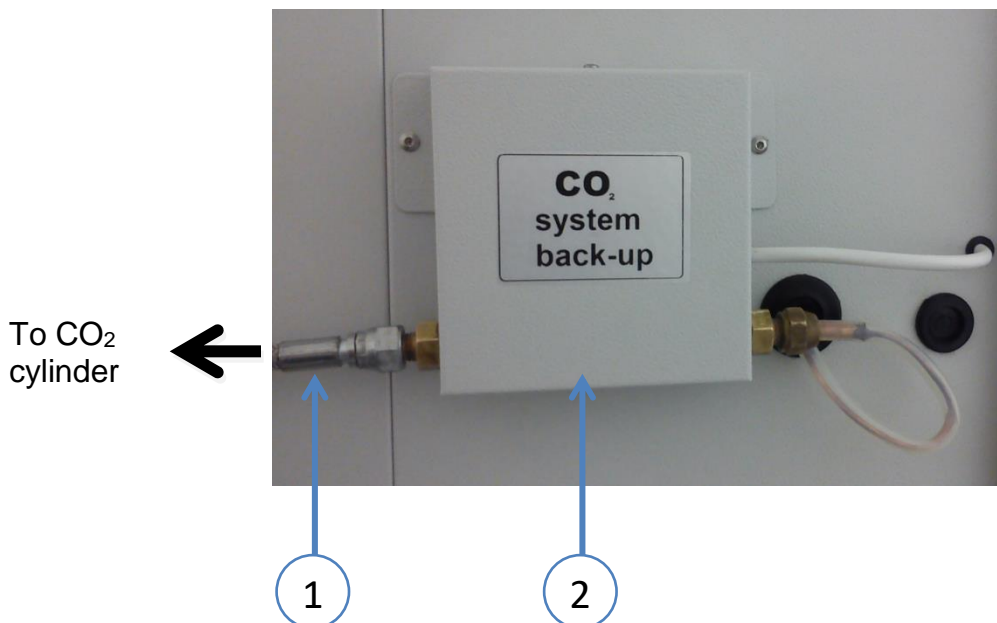

- 1) Steel hose for connecting CO₂ cylinder with 1/4" SAE internal thread
- 2) CO₂ back-up system

The manufacturer supplies the device with a specialist steel hose with a length of 1500 mm. This hose is used to connect CO₂ cylinder. On one side the hose is screwed to the CO₂ back-up system - **DO NOT** unscrew it. On the other side, it should be screwed to a CO₂ cylinder (see below "Connecting the equipment to a CO₂ cylinder"). The kit comes with a reduction on cylinder W21,8 x 1/4 " SAE. The minimum bend radius of the hose is 110 [mm].





The bending radius of the steel hose should not be smaller than specified in the documentation, otherwise the hose or its teflon inner coating may be damaged. Prevent:

- sharp hose bends near the ends,
- twisting, cutting, rubbing, stretching and squeezing the hose,
- exceeding the maximum solenoid working pressure of 70 bar,
- if you notice any signs of damage of the components, replace it.

To connect the freezer to a CO₂ cylinder you have to:

- 1) place the CO₂ cylinder vertically and attach it to the wall with a special clamp, rope or chain,
- 2) screw the supplied reduction W21,8 x 1/4 " SAE on the cylinder connector,
- 3) screw the hose to the reduction,
- 4) slowly unscrew the valve while checking low leakage connection,

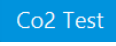
- 5) after connecting the cylinder correctly, press the main menu icon  and then press  (Figure 56); press the button  (Figure 57) and carry out the solenoid valve opening test.



When working on CO₂ back-up system is recommended to lock the freezer's door with a key.

Figure 56 CO₂ Test

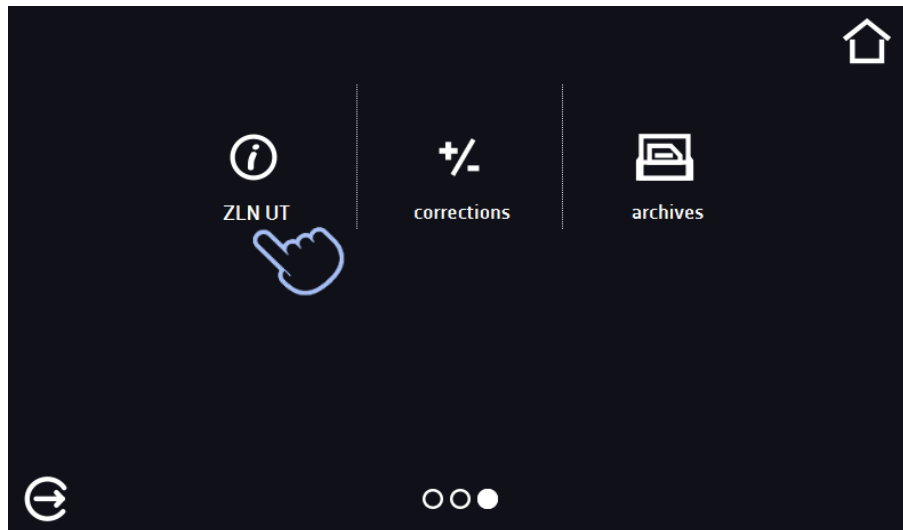
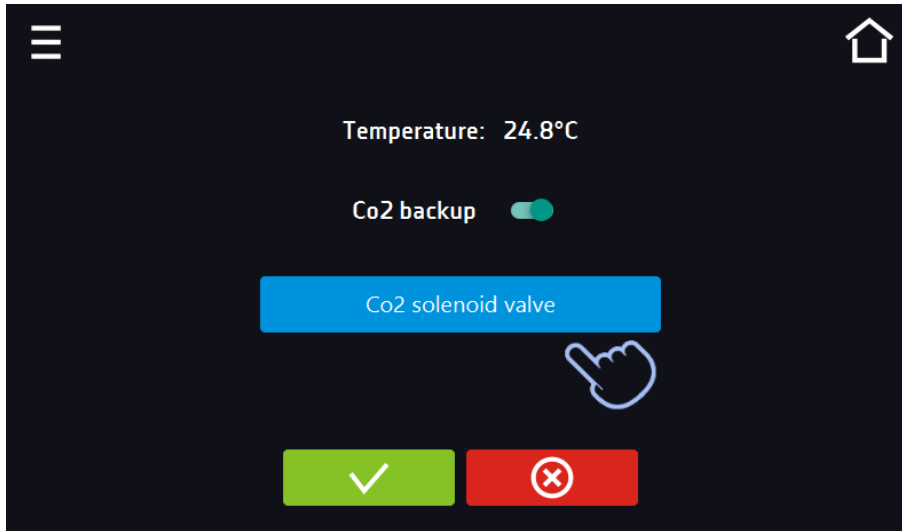
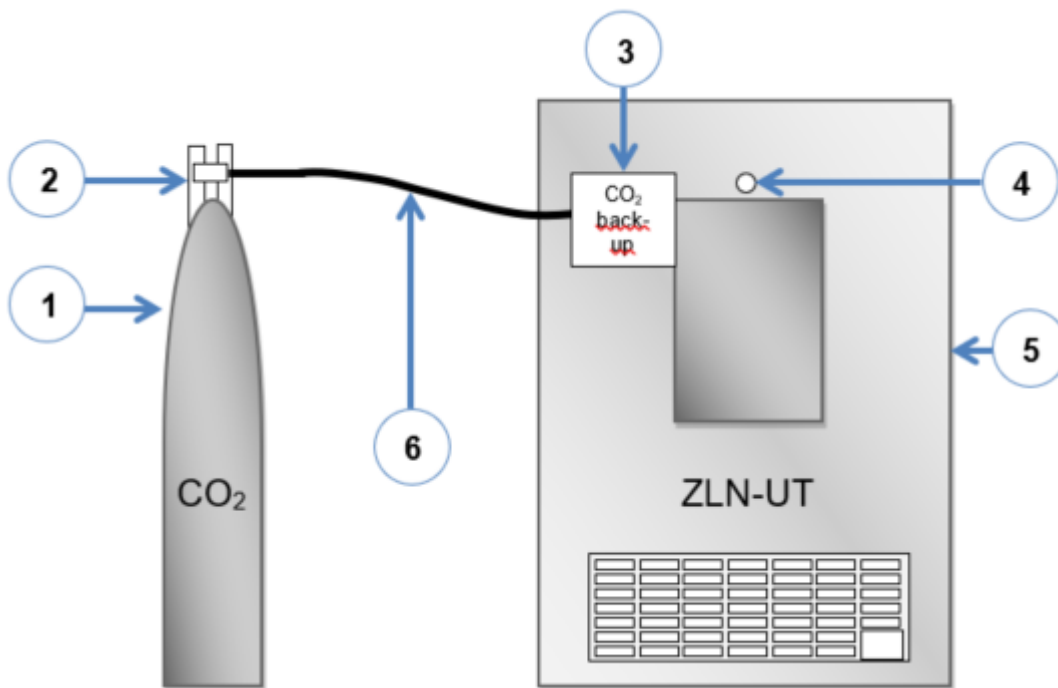

Figure 57 CO2 Test



When the button is pressed, the CO2 valve opens, accompanied by a loud noise and a drop in temperature.

Connection diagram of a CO₂ cylinder with a freezer:



- 1) cylinder containing CO₂
- 2) CO₂ cylinder valve
- 3) CO₂ back-up system
- 4) pressure reducer of the freezer's chamber
- 5) freezer
- 6) steel hose for connecting a CO₂ cylinder ended with an internal thread W21,8 according to DIN477



CO₂ back-up system should be connected to a **siphon cylinder**.



The manufacturer does not provide the equipment with a CO₂ cylinder.



Water condensation on the solenoid valve and steel hose is a natural phenomenon (only during operation of the CO₂ back-up system).





Connection to a CO₂ cylinder should be made by a person who has undergone appropriate training.

8.5. Disconnecting the freezer from the CO₂ cylinder

To disconnect the freezer from the CO₂ cylinder:

1) close the cylinder's valve,

2) press the main menu icon , and then press  (Figure 58); using the button  (Figure 59) perform the solenoid valve opening test three times to empty the gas in the connection,

3) unscrew the connection and reduction of W21,8 x 1/4 " SAE from the CO₂ cylinder.

8.6. CO₂ Backup solenoid valve

When the CO₂ backup solenoid valve is opened, the Start backup CO₂ entry appears as an alarm in the event log. When the CO₂ backup solenoid valve is closed, the Stop CO₂ backup record appears as an alarm in the event log.

When Backup CO₂ is operated for the first time, Backup CO₂ is displayed;

- the CO₂ solenoid valve is open - active state,
- the CO₂ solenoid valve is closed - inactive state.

When the CO₂ solenoid valve is open, a pulsating red frame and a red alarm bar appear on the display. When the CO₂ solenoid is closed, there is no pulsating frame and the bar is blue.

8.7. Starting the device

To start the device, turn the key of the rotary switch (Figure 60) of the CO₂ back-up system to the "ON" position, and then turn the main switch to the "I" position.



It is not recommended to open the freezer door during operation of the CO₂ back-up system because it causes a sudden increase of the temperature in the chamber of the equipment, and thus an increase in the amount of CO₂ dosed.

During the system operation, frost will accumulate in the device - this is normal. CO₂ dosing is done through the nozzles inside the freezer.



The manufacturer does not recommend placing the samples directly under the CO₂ nozzle. Covering the perforations on the device shelves reduces the efficiency of the system.

9. CONNECTING THE DEVICE TO A COMPUTER

Each device in the SMART version can be connected to an Ethernet network or directly to a computer with a LAN cable (optional). To read data (stored data and event log), you need the Lab Desk software (optional equipment). If you purchase the software, a LAN cable is included together with a hardware key, which should be inserted into the USB port of the computer. The installed Lab Desk software and hardware key allow reading the data stored in the internal memory of the device. The features of the software have been described in a separate instruction manual.

10. CLEANING AND MAINTENANCE OF THE DEVICE



Disconnect the device from the power supply before carrying out any activities related to the cleaning! In the case of the battery back-up of the controller (option), also turn it off.

On the internal walls of the device (in particular the new one) made of stainless steel, discoloration (spots) may appear - which are not caused by factory defects, but only by the steel production process. They can be cleaned using extraction gasoline.

INOX products are manufactured with stainless steel. When used in standard laboratory conditions they do not rust. However it is possible that stains (which may look like rust) form on the steel surface (e.g. due to the kind of samples that are incubated in the chamber). In such case we recommend using cleaning solution (to clean the stains) which is dedicated to this particular application, e.g. Pelox.



When cleaning stainless steel product with dedicated cleaning solution, one should pay attention to the suggestions and recommendations given in the instruction manual or in the safety data sheet of the cleaning solution.

10.1. Exterior cleaning

1.	The housing of the device should be cleaned at least once a week, depending on the working conditions.
2.	The housing and door should be cleaned with caution using a soft cloth dampened with water.
3.	Only mild cleaning products should be used to clean the device.
4.	Electrical parts should not get in contact with water or detergent.
5.	Clean the touch screen using a soft cloth or a foam for cleaning touch screens.
6.	USB port can be cleaned with a vacuum cleaner to prevent accumulation of dirt inside the port.

10.2. Interior cleaning

The interior of the freezers is made of stainless steel 0H17 acc. with DIN 1.4016 or 0H18 acc. with DIN 1.4301. Stainless steel also corrodes, but much less and slower than other types of steel. To slow down the corrosion process as much as possible, this type of steel requires regular maintenance and cleaning. Avoid aggressive cleaning agents and preparations based on chlorine and bleach, do not allow stainless steel to come into contact with non-alloy steel, unless you are dealing with ground steel, and avoid materials that may scratch the surface.

- | | |
|----|--|
| 1. | Before cleaning the interior of the device, empty the chamber. |
|----|--|

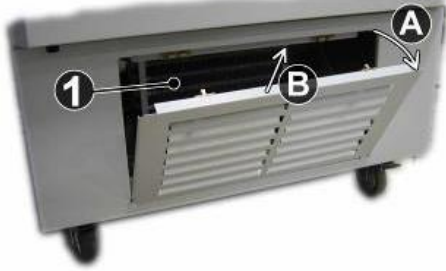
2.	After opening the appliance door, wait until the temperature in the chamber reaches the ambient temperature. After removing the shelves, you can start washing the device.
3.	To clean the device, use a lint-free, lint-free, soft cloth and water or water with a mild detergent.
4.	In the case of ground steel, movements should be made in the direction of grinding on the surface.
5.	<p>If rust occurs:</p> <ul style="list-style-type: none"> - slight discoloration - use household cleaners for stainless steel containing calcium carbonate or citric acid, - medium discoloration - clean with a 10% phosphoric acid solution; after cleaning, neutralize the acid with diluted ammonia or a mild alkaline detergent, - severe rust - use products for pickling and passivation of steel - for example Pelox FR-D <p>After each cleaning, wipe the surface thoroughly with clean water.</p>
6.	To clean the device, use water or water with a mild detergent.
7.	After cleaning, dry all surfaces thoroughly and reinstall the previously dismantled parts.
8.	When washing, pay special attention to the temperature sensors built in the chamber so as not to damage them.
9.	<p>At least once a month clean the condenser with a vacuum cleaner, dry cloth or a soft brush. Placement of the condenser in the freezers it's at the front in the bottom of the device. To access it, pull the ventilation cover (a) towards you and then pull it up (b). After cleaning the condenser (1), install the cover.</p> 

	<p>Failure to clean regularly may result in damage to the compressor and loss of the rights for repair under warranty.</p>
---	---

10.3. Cleaning the touch screen

The touch screen is exposed to dirt, so it must be cleaned regularly. To clean the touch screen, use a clean and dry microfiber cloth. It is a very delicate material and collects dirt well.

	<p>Before using the cloth, make sure that on the surface there are no crumbs or particles. During cleaning, they can act like sandpaper and scratch the surface of the screen.</p>
---	---

If the stains cannot be removed by dry cleaning, the cloth can be lightly dampened with water.

	<p>Do not use paper towels to clean the screen as it may cause microdamages.</p>
---	---

Before cleaning, lock the screen by pressing  on the top drop-down list (Figure 61)

Figure 61 Locking the screen

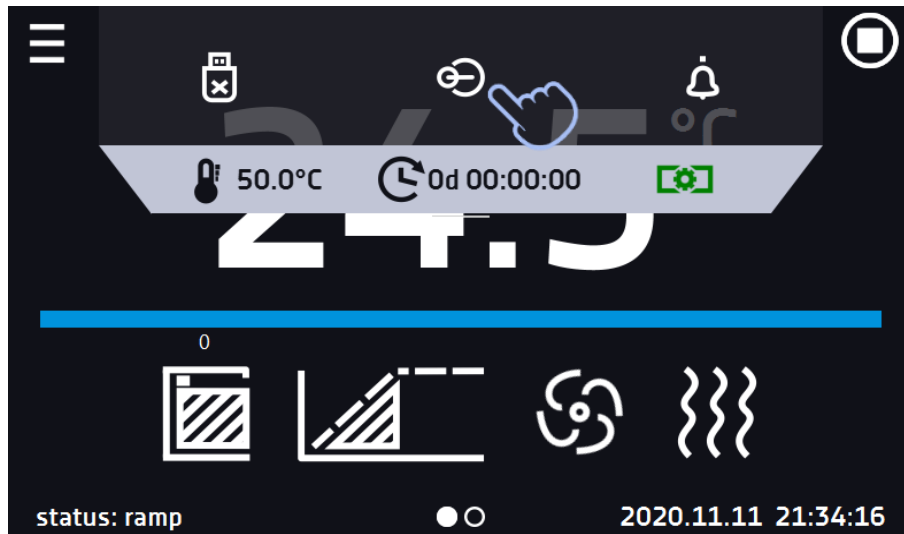

The screen is ready to be cleaned.

To unlock the touch screen, slide the blue circle into the white circle

Figure 62 Unlocking the screen

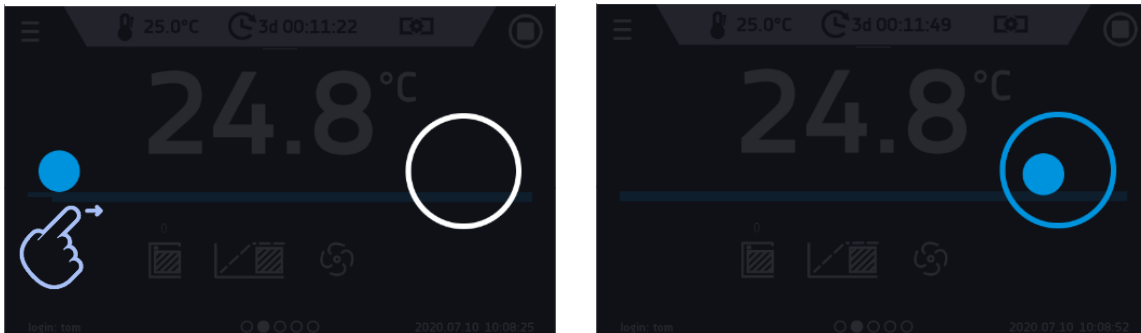

11. ADVICE ON HOW TO SAFELY STORE THE DEVICE

1.	Remove all objects from the chamber.
2.	Disconnect the device from the mains. If the unit is equipped with battery back-up of the controller (optional), also turn it off.
3.	Clean and dry the chamber.
4.	Leave the door open to avoid unpleasant odors.
5.	Store in temperatures between 0°C and 50°C and relative humidity maximum 70%.

12. TROUBLESHOOTING

Before you contact Service Department:

1.	Make sure that the operation complies with the instruction manual of the device.
2.	Restart the device to make sure that the unit is not functioning properly. If it still does not work, disconnect the unit again from the mains and repeat the operation after one hour. Do the same with optional battery back-up of the controller.

Service

Visit the POL-EKO website at: www.pol-eko.com.pl in order to:

- get full contact details of technical service
- access to POL-EKO online catalogue, and information about accessories and related products
- receive additional product information and special offers

To receive information or technical assistance, contact the Service Department or visit the website: www.pol-eko.com.pl

12.1. Possible defects

Malfunction	What to check?	What to do?
The unit is not working	Check if the unit is plugged in correctly	Plug in the unit correctly
	Check if the circuit-breaker has tripped	Press the circuit breaker on the back of the device
	Check the voltage in the socket	Connect the device to a different socket, preferably from a different electrical circuit. Call a licensed electrician to check the electrical installation.
	Check if the power cable is broken	Change the cable
The unit is not cooling down	Check if the condenser is dirty	Clean the condenser
	Check if the unit is exposed to direct sunlight	Change the location of the unit
	Check if there is a heat emitter near the device	Change the location of the unit
	Check if the door is closed properly	Clean the gasket
The unit is working too loud	Check if the unit is not touching other objects or furniture etc.	Remove other objects
	Check if the door is properly leveled	Level the device
The door has dropped or is skewed	Check if the door is properly leveled	Level the device. If this does not help, contact the service.
No battery backup of the display	Is the battery exhausted?	Replace the battery (replace the battery every 12 months)



Gurgling sound of the refrigerant fluid flowing in the refrigerant circuit is normal.

13. WARRANTY CONDITIONS

POL-EKO warrants that this product will be free from defects in material and workmanship for a period of two (2) years from date of the invoice. If a defect is present, POL-EKO will, at its option and cost, repair, replace, or refund the purchase price of this product to the customer, provided it is returned during the warranty period. This warranty does not apply if the product has been damaged by accident, abuse, misuse, or misapplication, or from ordinary wear and tear.

If the required maintenance and inspection services are not performed according to the manuals and any local regulations, such warranty turns invalid.

The device that is being returned must be secured by the customer in the event of any damage or loss. The warranty will be only limited to the situations listed above. IT IS EXPRESSLY AGREED THAT THIS WARRANTY WILL BE IN LIEU OF ALL WARRANTIES OF FITNESS AND IN LIEU OF THE WARRANTY OF MERCHANTABILITY.

All complaints should be reported using the form available on the website <http://www.pol-eko.com.pl/en/service>

Compliance with local laws and regulations

The user is responsible for obtaining any approvals or authorizations required to launch and use the product. POL-EKO shall not be liable for any negligence in the above matter except when the refusal to obtain authorization is caused by a product defect.

14. RATING PLATE

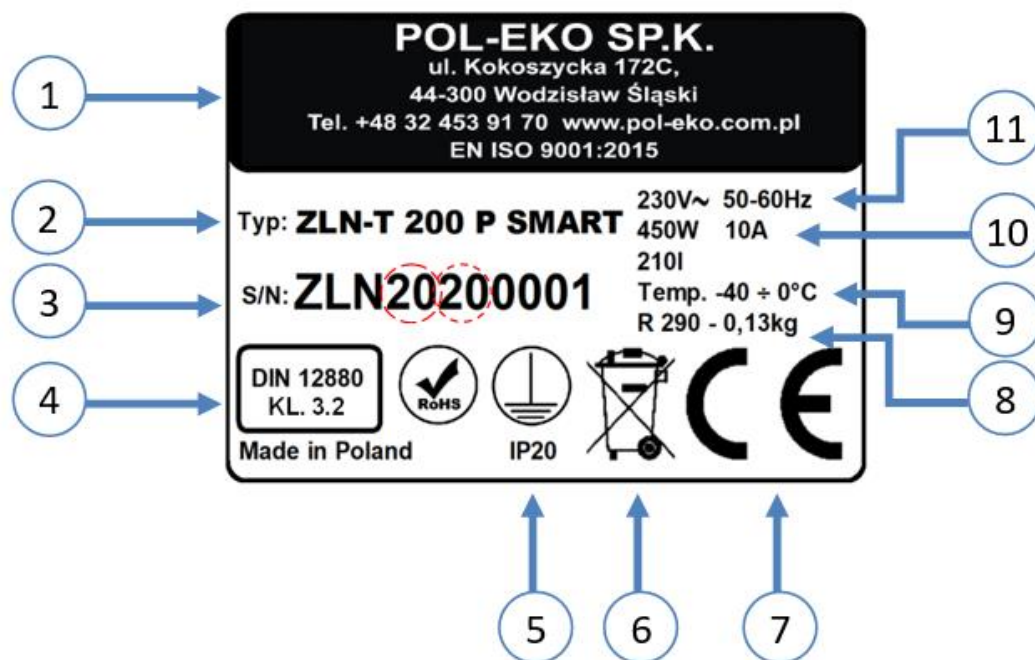

1. Manufacturer's data
2. Type of device
3. Serial number (the two marked digits indicate the year of manufacture of the device)
4. Temperature protection class according to DIN 12880
5. Degree of protection against electric shock (class I: protection against indirect contact) and IP enclosure protection rating
6. Disposal of used device according to WEEE2
7. CE marking as confirmation of compliance with the directives
8. Information about cooling system (gas type and quantity)
9. Temperature range of the device
10. Maximum power consumption, and capacity of device
11. Acceptable range of voltage and frequency of mains supply

15. TECHNICAL DATA

Technical data are given with a tolerance of $\pm 5\%$, the working capacity of the chamber is always smaller. All the below technical data refers to standard units (without optional accessories).

15.1. ZLN, ZLN-T, ZLW-T devices

Parameter	ZLN 85	ZLN-T 125	ZLN -T 200	ZLN- T 300	ZLW- T 200	ZLW-T 300	
Air Convection	natural				forced		
Chamber capacity [l]	85	130	210	310	210	310	
Working capacity [l]	73	109	180	262	140	213	
Door	solid						
Temperature range [°C]	- 25...0	-40...0					
Temperature range pracy [°F]	-13...32	-25,6...32					
Temperature resolution [°C]	every 0,1						
Controller	microprocessor with external touch screen 4,3'						
Interior	C Smart	stainless steel according to DIN 1.4016					
	CS Smart	stainless steel according to DIN 1.4016					
	P Smart	acid-proof stainless steel according to DIN 1.4301					
	PS Smart	acid-proof stainless steel according to DIN 1.4301					
Housing	C Smart	powder coated sheet					
	CS Smart	polished stainless steel					
	P Smart	powder coated sheet					
	PS Smart	polished stainless steel					
Overall dims ¹ [mm]	A width	610	720	820	820	820	
	B height	930	1190	1380	1730	1380	1730
	C depth	650	810	810	810	810	810
Internal dims [mm]	D width	380	370	450	450	450	450
	D' width	420	420	520	520	520	520
	E height	590	600	770	1120	770	1120
	F depth	400	520	520	520	520	520
	F' depth	440	530	530	530	530	530
	G depth	230	-	-	-	-	-
	H height	380	-	-	-	550	900
Max shelf workload ² [kg]	-	10	10	10	10	10	10
	version PW ³	-	50	50	50	50	50
Max unit wor- kload [kg]	-	30	50	65	80	65	80
	version W ⁴	-	100	130	160	160	160
Nominal power [W]	200	450	450	450	450	450	
Refrigerant gas	R290 / GWP=36	R290 / GWP=3	R290 / GWP=3	R290 / GWP=3	R290 / GWP=3	R290 / GWP=3	
Weight [kg]	62	105	120	185	120	185	
Power supply	230 V 50 Hz						
Shelves fitted/max	2/4	2/3	2/4	3/6	2/4	3/6	
Warranty	24 months						
Manufacturer	POL - EKO						

1. depth does not include 50mm of power cable
2. on uniformly loaded surface
3. reinforced shelf
4. reinforced version

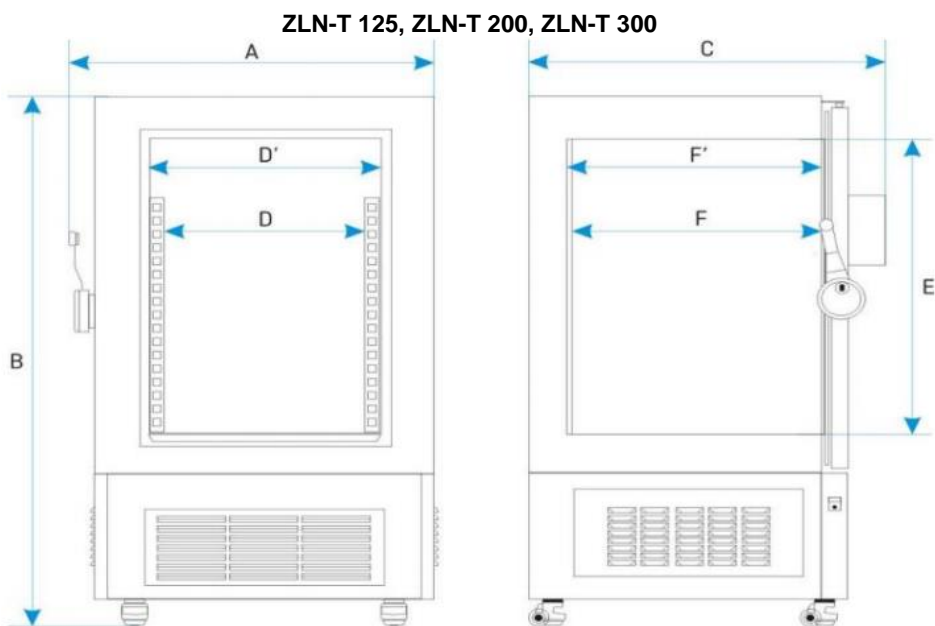
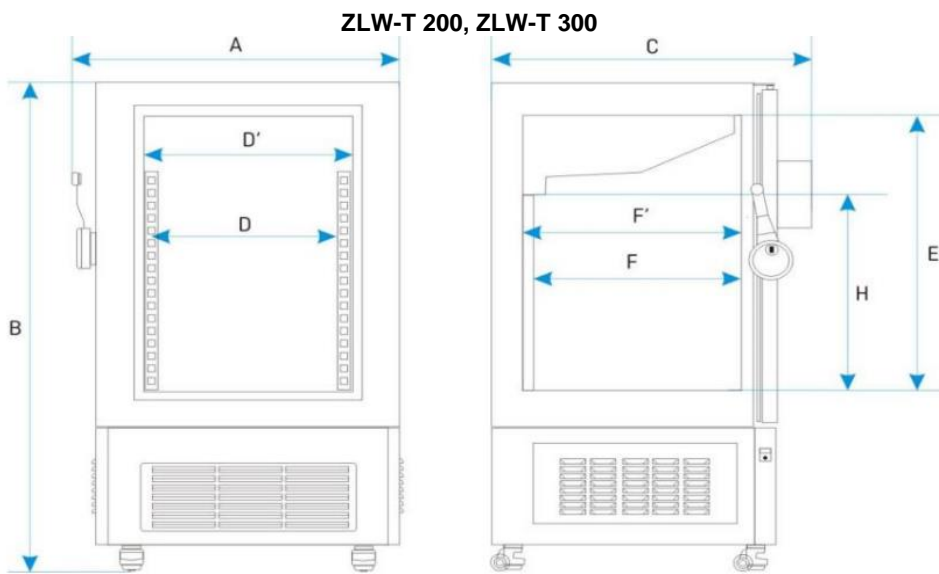
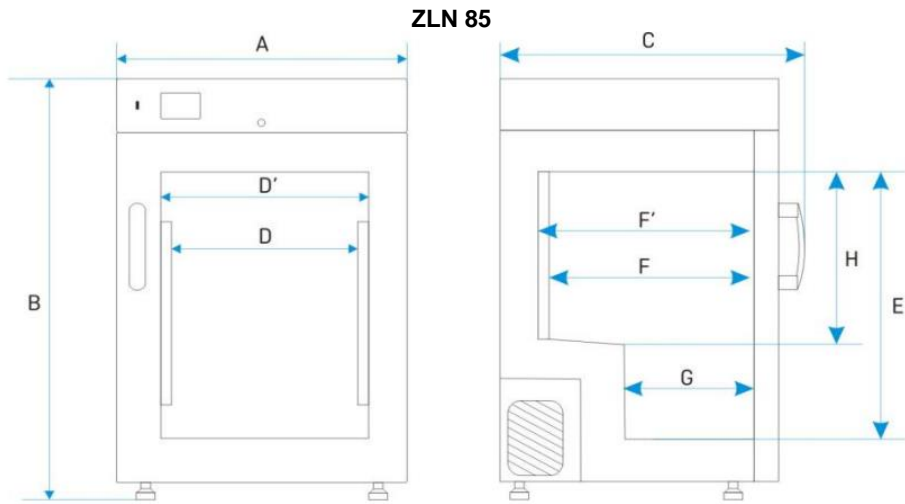

15.2. ZLN-UT VIP devices

Parametr		ZLN-UT 130 VIP	ZLN-UT 200 VIP	ZLN- UT 300 VIP	ZLN- UT 500 VIP
Air convection		natural			
Chamber capacity [l]		130	259	345	482
Number of boxes 133x133x50mm[pcs]		96	192	256	352
Door		solid			
Temperature range [°C]		-86 ...-50			
Temperature range [°F]		-122,8 ...-58			
Temperature resolution [°C]		every 0,1			
Controller		microprocessor with external touch screen			
Interior	C Smart	acid-proof stainless steel according to DIN 1.4016			
	P Smart	stainless steel according to DIN 1.4301			
Housing		powder coated sheet			
Overall dims ¹ [mm]	A width	800	880	880	880
	B height	940	1390	1620	2000
	C depth	960	960	960	960
Internal dims [mm]	D width	620	620	620	620
	E height	360	770	1000	1380
	F depth	580	580	580	580
	G height	-	360	480	670
Max unit workload [kg] ²		45	65	65	85
Max shelf workload [kg]		10	10	10	10
Nominal power [W]		2100	2100	2100	2100
Weight [kg]		147	200	220	243
Refrigerant gas		R290 / GWP=3 R170 / GWP=6	R290 / GWP=3 R170 / GWP=6	R290 / GWP=3 R170 / GWP=6	R290 / GWP=3 R170 / GWP=6
Number of compartments		1	2	2	2
Number of shelves std/max		1 1	2 2	2 2	4 4
Warranty		24 months			
Manufacturer		POL – EKO			

1. depth does not include 50mm of power cable
2. on uniformly loaded surface

ZLN-UT 130 VIP

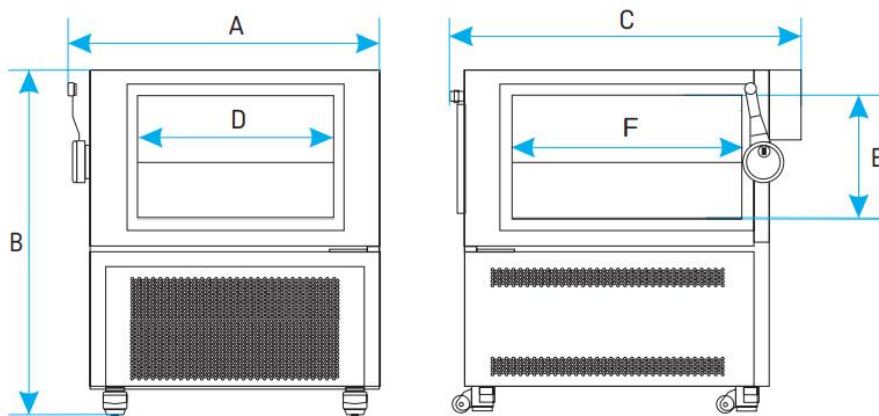

ZLN-UT 200 VIP

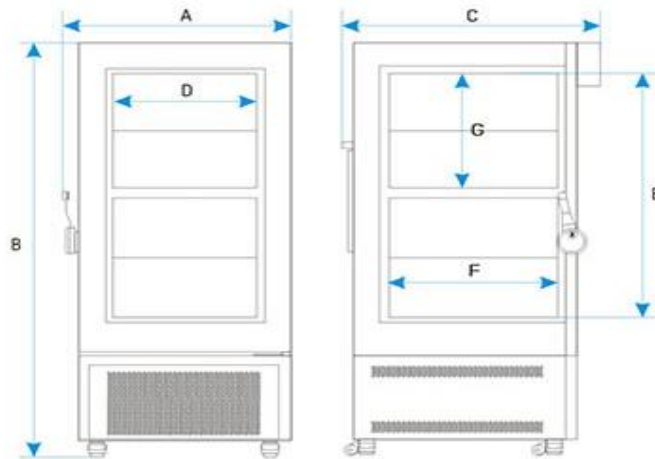

ZLN-UT 300 VIP

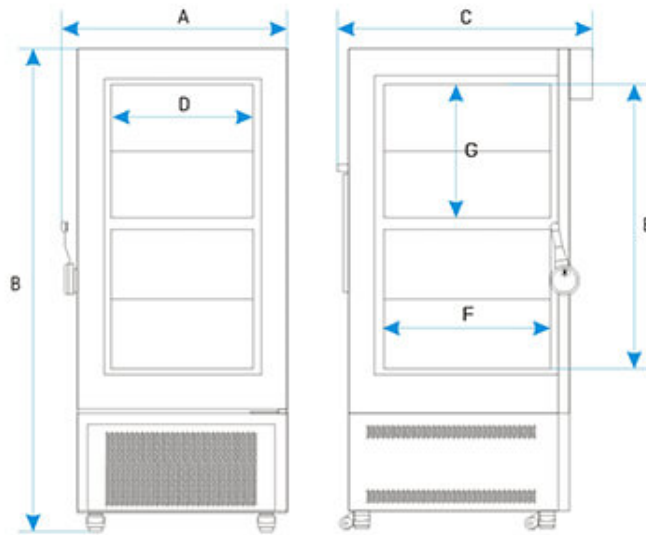

ZLN-UT 500 VIP

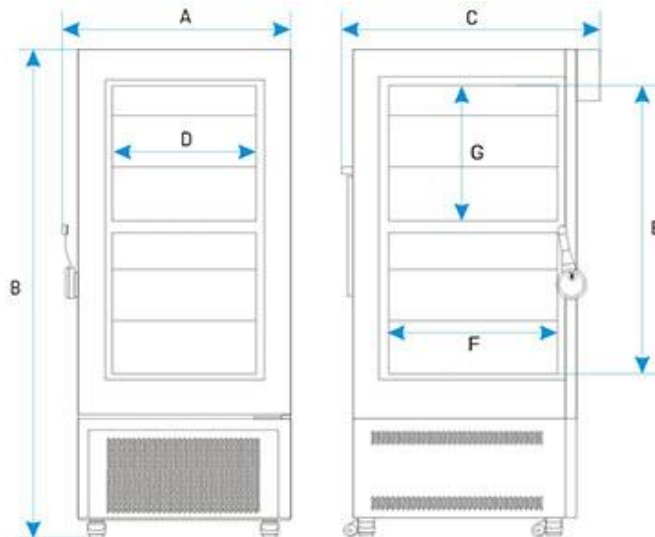

16. DECLARATIONS OF CONFORMITY

 DEKLARACJA ZGODNOŚCI UE EU DECLARATION OF CONFORMITY		 POL-EKO	
Produkt:	Zamrażarka laboratoryjna	Product:	Laboratory freezer
Model:	ZLN 85; ZLN-T 125; ZLN-T 200; ZLN-T 300; ZLW-T 200; ZLW-T 300		Model:
w wersjach:	C SMART; CS SMART; P SMART; PS SMART; P SMART PRO; PS SMART PRO.		in version:
Nazwa i adres producenta:	POL-EKO A.Polok-Kowalska sp.k. ul. Kokoszycka 172 C 44-300 Wodzisław Śląski Polska/Poland		
Niniejsza deklaracja zgodności wydana zostaje na wyłączną odpowiedzialność producenta.	<i>This declaration of conformity is issued under the sole responsibility of the manufacturer.</i>		
Wymieniony powyżej przedmiot niniejszej deklaracji jest zgodny z odnośnymi wymaganiami unijnego prawodawstwa harmonizacyjnego:	<i>The object of the declaration described above is in conformity with the relevant Union harmonisation legislation:</i>		
LVD 2014/35/UE EMC 2014/30/UE RoHS 2015/863 WEEE 2012/19/UE	LVD 2014/35/EU EMC 2014/30/EU RoHS 2015/863 WEEE 2012/19/EU		
Odniesienia do odnośnych norm zharmonizowanych, które zastosowano lub do innych specyfikacji technicznych, w stosunku do których deklarowana jest zgodność:	<i>References to the relevant harmonised standards used or references to the other technical specifications in relation to which conformity is declared:</i>		
LVD	PN-EN 61010-1:2011 PN-EN 60529:2003/A2:2014-07		
EMC	PN-EN IEC 61326-1:2021-10		
RoHS	PN-EN IEC 63000:2019-01		
Wodzisław Śl. 02.01.2023	W imieniu producenta podpisał:  Małgorzata Szafarczyk Dyrektor Generalny (CEO)		



DEKLARACJA ZGODNOŚCI UE
EU DECLARATION OF CONFORMITY



Produkt: Zamrażarka niskotemperaturowa	Product: Ultra-low freezer
Model: ZLN-UT 130 VIP; ZLN-UT 200 VIP; ZLN-UT 300 VIP; ZLN-UT 500 VIP	Model: ZLN-UT 130 VIP; ZLN-UT 200 VIP; ZLN-UT 300 VIP; ZLN-UT 500 VIP
w wersjach: C SMART; P SMART; P SMART PRO	in version: C SMART; P SMART; P SMART PRO
Nazwa i adres producenta: POL-EKO A.Polok-Kowalska sp.k. ul. Kokoszycka 172 C 44-300 Wodzisław Śląski Polska/Poland	Name and address of the manufacturer: POL-EKO A.Polok-Kowalska sp.k. ul. Kokoszycka 172 C 44-300 Wodzisław Śląski Polska/Poland
Niniejsza deklaracja zgodności wydana zostaje na wyłączną odpowiedzialność producenta.	This declaration of conformity is issued under the sole responsibility of the manufacturer.
Wymieniony powyżej przedmiot niniejszej deklaracji jest zgodny z odnośnymi wymaganiami unijnego prawodawstwa harmonizacyjnego: LVD 2014/35/UE EMC 2014/30/UE RoHS 2015/863 WEEE 2012/19/UE	The object of the declaration described above is in conformity with the relevant Union harmonisation legislation: LVD 2014/35/EU EMC 2014/30/EU RoHS 2015/863 WEEE 2012/19/EU
Odniesienia do odnośnych norm zharmonizowanych, które zastosowano lub do innych specyfikacji technicznych, w stosunku, do których deklarowana jest zgodność: LVD EMC RoHS	References to the relevant harmonised standards used or references to the other technical specifications in relation to which conformity is declared: PN-EN 61010-1:2011 PN-EN 60529:2003/A2:2014-07 PN-EN IEC 61326-1:2021-10 PN-EN IEC 63000:2019-01

Wodzisław Śl. 02.01.2023

W imieniu producenta podpisał:

M. Hofarczyk
Małgorzata Szafarczyk
Dyrektor Generalny (CEO)

Manufacturer of control and measurement equipment
for laboratory tests and technological processes,
distributor in Poland of the following companies:
HAMILTON, NICKEL ELECTRO, RODWELL, THERMO SCIENTIFIC, WTW.

We produce:

- thermostatic cabinets
- laboratory refrigerators
- laboratory incubators
- devices with photoperiod and phytotron system
- drying ovens and sterilizers
- drying ovens with nitrogen blow
- laboratory freezers
- ultra-low freezers
- climatic chambers
- Caldera fluid and blanket warmers
- colony counters
- laboratory shakers
- stationary samplers
- Hydromat water dispensers
- Eurodrop stations
- FEKO+ waste water receipt station
- heating ovens
- cooled incubators
- fume hoods

We offer portable, laboratory and on-line equipment:

- pH-meters
- ionmeters
- dissolved oxygen meters
- conductivity meters
- photometers and spectrophotometers
- thermo reactors
- turbidity metres
- pH electrodes
- conductivity sensors
- oxygen probes
- heavy metals trace analyzers
- water baths
- autoclaves
- pH buffer solutions
- conductivity standards
- photometric tests
- laboratory accessories
- consumables

We organize:

- regional trainings
- individual trainings
- seminars

We provide:

- warranty and post-warranty service
- consultancy in the selection, maintenance and operation of laboratory equipment

POL-EKO LAB is Accredited by the Polish Centre for Accreditation (a member of ILAC) and provides accredited calibration of:

- thermostatic and climatic chambers (incubators, drying ovens, thermostatic cabinets, climatic chambers, freezers)
- water baths and thermo reactors
- autoclaves
- electric and electronic thermometers
- data loggers
- high temperature laboratory furnaces
- thermohygrometers
- laboratory sieves

Calibration is confirmed with the issue of 'Calibration Certificate'.

Services outside the scope of accreditation:

- checking equipment for physicochemical measurements (meters and probes),
- carrying out IQ, OQ, PQ qualification procedures,
- mapping of temperature and humidity in the rooms



AP 115



POL-EKO
Perfect Environment

☎ (+48) 32 453 91 70
✉ info@pol-eko.com.pl
🌐 www.pol-eko.com.pl

📍 **POL-EKO A. Polok - Kowalska sp.k.**
44-300 Wodzisław Śląski
ul. Kokoszycka 172 C